



**Thienes Engineering, Inc.**  
CIVIL ENGINEERING • LAND SURVEYING

# Final Water Quality Management Plan (WQMP)

For:

**Hillwood Gateway South Building 8  
NWC of Norman Road and Lena Road  
San Bernardino, CA 92408**

**DP-D XX-XX / THRXX-XXX**

APNs: 0280-161-03, 05, 06, 07, 08, 09, 10, 11, 12, 13, 14, 15, 16, 17, 18, 21, 30, 31;  
0280-171-01, 02, 03, 04, 05, 06, 07, 08, 09, 10, 11

**Prepared for:**

Hillwood Investments  
901 Via Piemonte, Suite 175  
Ontario, CA 91764  
Phone: (909) 382-0033  
Contact: John M. Magness

**Prepared by:**

Thienes Engineering, Inc.  
14349 Firestone Boulevard  
La Mirada, CA 90638  
Phone: (714) 521-4811  
Contact: Mira Bogdanova (mira@thieneseng.com)  
Job No. 3575

**Approval Date:** \_\_\_\_\_

**Implementation Date:** \_\_\_\_\_

**1<sup>st</sup> Submittal:** \_\_\_\_\_ March 25, 2022

**2<sup>nd</sup> Submittal:** \_\_\_\_\_

**3<sup>rd</sup> Submittal:** \_\_\_\_\_

## Project Owner's Certification

This Water Quality Management Plan (WQMP) has been prepared for **Hillwood Investments** by **Thienes Engineering, Inc.** The WQMP is intended to comply with the requirements of the **City of San Bernardino** and the NPDES Areawide Stormwater Program requiring the preparation of a WQMP.

The undersigned, while it owns the subject property, is responsible for the implementation of the provisions of this plan and will ensure that this plan is amended as appropriate to reflect up-to-date conditions on the site consistent with the San Bernardino County's Municipal Storm Water Management Program and the intent of the NPDES Permit for San Bernardino County and the incorporated cities of San Bernardino County within the Santa Ana Region. Once the undersigned transfers its interest in the property, its successors in interest and the city/county shall be notified of the transfer. The new owner will be informed of its responsibility under this WQMP. A copy of the approved WQMP shall be available on the subject site in perpetuity.

"I certify under a penalty of law that the provisions (implementation, operation, maintenance, and funding) of the WQMP have been accepted and that the plan will be transferred to future successors."



Project Data			
<b>Permit/Application Number(s):</b>	DP-D XX-XX / THRXX-XXX	<b>Grading Permit Number(s):</b>	LDXXXXXXX
<b>Tract/Parcel Map Number(s):</b>		<b>Building Permit Number(s):</b>	
<b>CUP, SUP, and/or APN (Specify Lot Numbers if Portions of Tract):</b>		APNs: 0280-161-03, 05, 06, 07, 08, 09, 10, 11, 12, 13, 14, 15, 16, 17, 18, 21, 30, 31; 0280-171-01, 02, 03, 04, 05, 06, 07, 08, 09, 10, 11	
Owner's Signature			
<b>Owner Name: Hillwood Investments</b>			
<b>Title</b>	John M. Magness, Senior Vice President		
<b>Company</b>	Hillwood Investments		
<b>Address</b>	901 Via Piemonte, Suite 175, Ontario, CA 91764		
<b>Email</b>	john.magness@hillwood.com		
<b>Telephone #</b>	(909) 382-0033		
<b>Signature</b>		<b>Date</b>	



## Preparer's Certification

Project Data			
Permit/Application Number(s):	DP-D XX-XX / THRXX-XXX	Grading Permit Number(s):	LDXXXXXXX
Tract/Parcel Map Number(s):		Building Permit Number(s):	
CUP, SUP, and/or APN (Specify Lot Numbers if Portions of Tract):		APNs: 0280-161-03, 05, 06, 07, 08, 09, 10, 11, 12, 13, 14, 15, 16, 17, 18, 21, 30, 31; 0280-171-01, 02, 03, 04, 05, 06, 07, 08, 09, 10, 11	

“The selection, sizing and design of stormwater treatment and other stormwater quality and quantity control measures in this plan were prepared under my oversight and meet the requirements of Regional Water Quality Control Board Order No. R8-2010-0036.”

<b>Engineer: Reinhard Stenzel</b>		<p><b>PE Stamp Below</b></p> 
Title	Director of Engineering	
Company	Thienes Engineering, Inc.	
Address	14349 Firestone Boulevard, La Mirada, CA 90638	
Email	reinhard@thieneseng.com	
Telephone #	(714) 521-4811	
Signature		

# Contents

Section 1	Discretionary Permit(s) .....	1-1
Section 2	Project Description.....	2-1
2.1	Project Information.....	2-1
2.2	Property Ownership/Management .....	2-2
2.3	Potential Stormwater Pollutants .....	2-2
2.4	Water Quality Credits .....	2-3
Section 3	Site and Watershed Description .....	3-1
Section 4	Best Management Practices (BMP) .....	4-1
4.1	Source Control BMP .....	4-1
4.1.1	Pollution Prevention .....	4-1
4.1.2	Preventive LID Site Design Practices .....	4-6
4.2	Project Performance Criteria .....	4-7
4.3	Project Conformance Analysis .....	4-12
4.3.1	Site Design Hydrologic Source Control BMP .....	4-14
4.3.2	Infiltration BMPs .....	4-16
4.3.3	Harvest and Use BMP.....	4-18
4.3.4	Biotreatment BMP .....	4-19
4.3.5	Conformance Summary .....	4-23
4.3.6	Hydromodification Control BMP.....	4-24
4.4	Alternative Compliance Plan (if applicable).....	4-25
Section 5	Inspection and Maintenance Responsibility for Post Construction BMP .....	5-1
Section 6	WQMP Attachments .....	6-1
6.1	Site Plan and Drainage Plan .....	6-1
6.2	Electronic Data Submittal .....	6-1
6.3	Post Construction.....	6-1
6.4	Other Supporting Documentation .....	6-1

## Forms

Form 1-1 Project Information .....	1-1
Form 2.1-1 Description of Proposed Project .....	2-1
Form 2.2-1 Property Ownership/Management .....	2-2
Form 2.3-1 Pollutants of Concern .....	2-2
Form 2.4-1 Water Quality Credits .....	2-3
Form 3-1 Site Location and Hydrologic Features .....	3-1
Form 3-2 Existing Hydrologic Characteristics for Drainage Area (DA 1) .....	3-2
Form 3-4 Watershed Description .....	3-3
Form 4.1-1 Non-Structural Source Control BMPs .....	4-2
Form 4.1-2 Structural Source Control BMPs .....	4-4
Form 4.1-3 Preventive LID Site Design Practices Checklist .....	4-6
Form 4.2-1 LID BMP Performance Criteria for Design Capture Volume (DA 1) .....	4-7
Form 4.2-2 Summary of HCOC Assessment .....	4-8
Form 4.2-3 HCOC Assessment for Runoff Volume .....	4-9
Form 4.2-4 HCOC Assessment for Time of Concentration .....	4-10
Form 4.2-5 HCOC Assessment for Peak Runoff .....	4-11
Form 4.3-1 Infiltration BMP Feasibility .....	4-13
Form 4.3-2 Site Design Hydrologic Source Control BMPs .....	4-15
Form 4.3-3 Infiltration LID BMP (including underground BMPs) .....	4-17
Form 4.3-4 Harvest and Use BMPs .....	4-18
Form 4.3-5 Selection and Evaluation of Biotreatment BMP .....	4-19
Form 4.3-6 Volume Based Biotreatment – Bioretention and Planter Boxes with Underdrains .....	4-20
Form 4.3-7 Volume Based Biotreatment – Constructed Wetlands and Extended Detention .....	4-21
Form 4.3-8 Flow Based Biotreatment .....	4-22
Form 4.3-9 Conformance Summary and Alternative Compliance Volume Estimate .....	4-23
Form 4.3-10 Hydromodification Control BMPs .....	4-24
Form 5-1 BMP Inspection and Maintenance .....	5-1

## Attachments

- Attachment A: Existing Condition Site Photos
- Attachment B: BMP Design Calculations & Supporting Documentation
- Attachment C: WQMP Site Map
- Attachment D: WQMP and Stormwater BMP Transfer, Access and Maintenance Agreement
- Attachment E: Educational Materials
- Attachment F: Infiltration Report
- Attachment G: BMP O&M

## Section 1 Discretionary Permit(s)

<b>Form 1-1 Project Information</b>					
<b>Project Name</b>		Hillwood Gateway South Building 8			
<b>Project Owner Contact Name:</b>		John M. Magness			
<b>Mailing Address:</b>	901 Via Piemonte, Suite 175 Ontario, CA 91764	<b>E-mail Address:</b>	john.magness@hillwood.com	<b>Telephone:</b>	(909) 382-0033
<b>Permit/Application Number(s):</b>		DP-D XX-XX / THRXX-XXX	<b>Tract/Parcel Map Number(s):</b>		
<b>Additional Information/ Comments:</b>		n/a			
<b>Description of Project:</b>		<p>The project site encompasses approximately 11.95 acres. Proposed improvements the site include one commercial type building with a truck yard on the north side of the building. Vehicle parking lots will be located along the northeasterly and westerly sides of the building. An underground infiltration facility will be in the truck yard area. The remainder of this project site will be utilized for landscaping.</p> <p>A majority of the site will drain to catch basins in the truck yard and westerly parking lot. Roof runoff from the southerly half of the building will route the water quality flowrate to the chambers in the truck yard. Southerly roof runoff will be conveyed westerly, northerly, then easterly, via the proposed storm drain. Prior to discharging to the onsite public storm drain, the site's DCV will be diverted to the underground chambers for infiltration.</p> <p>The site's southerly landscape will surface drain southerly to Norman Road. This area (totaling to 0.40 acres) will drain off-site without being routed to the proposed LID BMPs. The landscaped areas draining offsite are considered self-treating areas. Additionally, the site's northeasterly driveway and landscape area (0.05 acres) will drain off-site without being routed to the LID BMPs.</p> <p>A temporary inlet in the northwesterly part of Foisy Street site will receive flows from Foisy Street. This inlet will be capped when Foisy Street undergoes street improvements.</p>			
<b>Provide summary of Conceptual WQMP conditions (if previously submitted and approved). Attach complete copy.</b>		n/a			

## Section 2 Project Description

### 2.1 Project Information

This section of the WQMP should provide the information listed below. The information provided for Conceptual/ Preliminary WQMP should give sufficient detail to identify the major proposed site design and LID BMPs and other anticipated water quality features that impact site planning. Final Project WQMP must specifically identify all BMP incorporated into the final site design and provide other detailed information as described herein.

The purpose of this information is to help determine the applicable development category, pollutants of concern, watershed description, and long term maintenance responsibilities for the project, and any applicable water quality credits. This information will be used in conjunction with the information in Section 3, Site Description, to establish the performance criteria and to select the LID BMP or other BMP for the project or other alternative programs that the project will participate in, which are described in Section 4.

<b>Form 2.1-1 Description of Proposed Project</b>					
<b><sup>1</sup> Development Category (Select all that apply):</b>					
<input type="checkbox"/> Significant re-development involving the addition or replacement of 5,000 ft <sup>2</sup> or more of impervious surface on an already developed site	<input checked="" type="checkbox"/> New development involving the creation of 10,000 ft <sup>2</sup> or more of impervious surface collectively over entire site	<input type="checkbox"/> Automotive repair shops with standard industrial classification (SIC) codes 5013, 5014, 5541, 7532-7534, 7536-7539	<input type="checkbox"/> Restaurants (with SIC code 5812) where the land area of development is 5,000 ft <sup>2</sup> or more		
<input type="checkbox"/> Hillside developments of 5,000 ft <sup>2</sup> or more which are located on areas with known erosive soil conditions or where the natural slope is 25 percent or more	<input type="checkbox"/> Developments of 2,500 ft <sup>2</sup> of impervious surface or more adjacent to (within 200 ft) or discharging directly into environmentally sensitive areas or waterbodies listed on the CWA Section 303(d) list of impaired waters.	<input checked="" type="checkbox"/> Parking lots of 5,000 ft <sup>2</sup> or more exposed to storm water	<input type="checkbox"/> Retail gasoline outlets that are either 5,000 ft <sup>2</sup> or more, or have a projected average daily traffic of 100 or more vehicles per day		
<input type="checkbox"/> Non-Priority / Non-Category Project <i>May require source control LID BMPs and other LIP requirements. Please consult with local jurisdiction on specific requirements.</i>					
<b><sup>2</sup> Project Area (ft<sup>2</sup>):</b>	520,542 (11.50 acres) *	<b><sup>3</sup> Number of Dwelling Units:</b>	n/a	<b><sup>4</sup> SIC Code:</b>	4225
<b><sup>5</sup> Is Project going to be phased?</b> <input type="checkbox"/> Yes <input checked="" type="checkbox"/> No <i>If yes, ensure that the WQMP evaluates each phase as a distinct DA, requiring LID BMPs to address runoff at time of completion.</i>					
<b><sup>6</sup> Does Project include roads?</b> <input type="checkbox"/> Yes <input checked="" type="checkbox"/> No <i>If yes, ensure that applicable requirements for road projects are addressed (see Appendix A of TGD for WQMP)</i>					

\* The entire project area is 11.95 acres. This value does not include 0.45 acres of areas that do not drain to the proposed LID BMP.

## 2.2 Property Ownership/Management

Describe the ownership/management of all portions of the project and site. State whether any infrastructure will transfer to public agencies (City, County, Caltrans, etc.) after project completion. State if a homeowners or property owners association will be formed and be responsible for the long-term maintenance of project stormwater facilities. Describe any lot-level stormwater features that will be the responsibility of individual property owners.

<b>Form 2.2-1 Property Ownership/Management</b>	
Describe property ownership/management responsible for long-term maintenance of WQMP stormwater facilities:	
Hillwood Investments 901 Via Piemonte, Suite 175 Ontario, CA 91764 Phone: (909) 382-0033 Contact: John M. Magness	
No infrastructure will be transferred to a public agency after project completion. A property owner's association (POA) will not be formed for long-term maintenance of project stormwater facilities.	

## 2.3 Potential Stormwater Pollutants

Determine and describe expected stormwater pollutants of concern based on land uses and site activities (refer to Table 3-3 in the TGD for WQMP).

<b>Form 2.3-1 Pollutants of Concern</b>				
Pollutant	Circle One: E=Expected, N=Not Expected		Listed for Receiving Water	Additional Information and Comments
Pathogens (Bacterial / Virus)	Ⓔ	N	X	Source: Bacterial indicators are routinely detected in pavement runoff. Impaired water: Santa Ana River, Reach 3 and 4
Nutrients - Phosphorous	Ⓔ	N		Source: Landscaping exists on-site.
Nutrients - Nitrogen	Ⓔ	N		Source: Landscaping exists on-site.
Noxious Aquatic Plants	Ⓔ	N		Source: Landscaping exists on-site.
Sediment	Ⓔ	N		Source: Landscaping exists on-site.
Metals	Ⓔ	N	X	Source: Metal products, wear associated with driving. Impaired water: Santa Ana River, Reach 3
Oil and Grease	Ⓔ	N		Source: Landscaping exists on-site, vehicles present.
Trash / Debris	Ⓔ	N		Source: Landscaping exists on-site.
Pesticides / Herbicides	Ⓔ	N		Source: Landscaping exists on-site.
Organic Compounds	Ⓔ	N	X	Including petroleum hydrocarbons and solvents. Source: Landscaping exists on-site. Impaired water: Santa Ana River, Reach 3
Other:				

The expected POCs for the project site are ***Pathogens, Organic Compounds, and Metals.***

## 2.4 Water Quality Credits

A water quality credit program is applicable for certain types of development projects if it is not feasible to meet the requirements for on-site LID. Proponents for eligible projects, as described below, can apply for water quality credits that would reduce project obligations for selecting and sizing other treatment BMP or participating in other alternative compliance programs. Refer to Section 6.2 in the TGD for WQMP to determine if water quality credits are applicable for the project.

<b>Form 2.4-1 Water Quality Credits</b>			
<b><sup>1</sup> Project Types that Qualify for Water Quality Credits:</b> <i>Select all that apply</i>			
<input type="checkbox"/> Redevelopment projects that reduce the overall impervious footprint of the project site. [Credit = % impervious reduced]	Higher density development projects <input type="checkbox"/> Vertical density [20%] <input type="checkbox"/> 7 units/ acre [5%]	<input type="checkbox"/> Mixed use development, (combination of residential, commercial, industrial, office, institutional, or other land uses which incorporate design principles that demonstrate environmental benefits not realized through single use projects) [20%]	<input type="checkbox"/> Brownfield redevelopment (redevelop real property complicated by presence or potential of hazardous contaminants) [25%]
<input type="checkbox"/> Redevelopment projects in established historic district, historic preservation area, or similar significant core city center areas [10%]	<input type="checkbox"/> Transit-oriented developments (mixed use residential or commercial area designed to maximize access to public transportation) [20%]	<input type="checkbox"/> In-fill projects (conversion of empty lots & other underused spaces < 5 acres, substantially surrounded by urban land uses, into more beneficially used spaces, such as residential or commercial areas) [10%]	<input type="checkbox"/> Live-Work developments (variety of developments designed to support residential and vocational needs) [20%]
<b><sup>2</sup> Total Credit %:</b> n/a <i>(Total all credit percentages up to a maximum allowable credit of 50 percent)</i>			
<b>Description of Water Quality Credit Eligibility (if applicable)</b>	n/a		

The proposed project will **not** utilize any water quality credits.

## Section 3 Site and Watershed Description

Describe the project site conditions that will facilitate the selection of BMP through an analysis of the physical conditions and limitations of the site and its receiving waters. Identify distinct drainage areas (DA) that collect flow from a portion of the site and describe how runoff from each DA (and sub-watershed DMAs) is conveyed to the site outlet(s). Refer to Section 3.2 in the TGD for WQMP. Complete form 3.2 for each DA on the project site.

<b>Form 3-1 Site Location and Hydrologic Features</b>			
<b>Site coordinates</b> <i>Take GPS measurement at approximate center of site</i>	<b>Latitude:</b> 34.082156	<b>Longitude:</b> -117.27353	<b>Thomas Bros Map page:</b> Page 607
<b><sup>1</sup> San Bernardino County climatic region:</b> <input checked="" type="checkbox"/> Valley <input type="checkbox"/> Mountain <input type="checkbox"/> Desert			
<b><sup>2</sup> Does the site have more than one drainage area (DA):</b> <input type="checkbox"/> Yes <input checked="" type="checkbox"/> No			
<i>If no, proceed to Form 3-2. If yes, then use this form to show a conceptual schematic describing DMAs and hydrologic feature connecting DMAs to the site outlet(s). An example is provided below that can be modified for proposed project or a drawing clearly showing DMA and flow routing may be attached.</i>			



### Form 3-2 Existing Hydrologic Characteristics for Drainage Area (DA 1)

For each drainage area's sub-watershed DMA, provide the following characteristics	DMA A West	DMA A East	n/a	n/a
<sup>1</sup> DMA drainage area (ft <sup>2</sup> )	293,594 (6.74 acres)	226,948 (5.21 acres)	n/a	n/a
<sup>2</sup> Existing site impervious area (ft <sup>2</sup> )	0	0	n/a	n/a
<sup>3</sup> Antecedent moisture condition <i>For desert areas, use <a href="http://www.sbcounty.gov/dpw/floodcontrol/pdf/20100412_map.pdf">http://www.sbcounty.gov/dpw/floodcontrol/pdf/20100412_map.pdf</a></i>	AMC II	AMC II	n/a	n/a
<sup>4</sup> Hydrologic soil group <i>Refer to Watershed Mapping Tool – <a href="http://sbcounty.permitrack.com/WAP">http://sbcounty.permitrack.com/WAP</a></i>	HSG B	HSG B	n/a	n/a
<sup>5</sup> Longest flowpath length (ft)	653	477	n/a	n/a
<sup>6</sup> Longest flowpath slope (ft/ft)	0.0037	0.0068	n/a	n/a
<sup>7</sup> Current land cover type(s) <i>Select from Fig C-3 of Hydrology Manual</i>	Residential/Barren	Residential/Barren	n/a	n/a
<sup>8</sup> Pre-developed pervious area condition: <i>Based on the extent of wet season vegetated cover good &gt;75%; Fair 50-75%; Poor &lt;50% See Attachment A for photos of site to support rating</i>	Poor	Poor	n/a	n/a

<b>Form 3-3 Watershed Description</b>	
<p><b>Receiving Waters</b> Refer to Watershed Mapping Tool - <a href="http://sbcounty.permitrack.com/WAP">http://sbcounty.permitrack.com/WAP</a> See "Drainage Facilities" link at this website</p>	<p>Twin Creek Channel Santa Ana River, Reach 5 Santa Ana River, Reach 4 Santa Ana River, Reach 3 Prado Dam Santa Ana River, Reach 2 Santa Ana River, Reach 1 Pacific Ocean</p>
<p><b>Applicable TMDLs</b> Refer to Local Implementation Plan</p>	<p>Twin Creek Channel: None Santa Ana River, Reach 5: None Santa Ana River, Reach 4: None Santa Ana River, Reach 3: Pathogens, Nitrate Prado Dam: Pathogens Santa Ana River, Reach 2: None Santa Ana River, Reach 1: None Pacific Ocean: None</p>
<p><b>303(d) listed impairments</b> Refer to Local Implementation Plan and Watershed Mapping Tool – <a href="http://sbcounty.permitrack.com/WAP">http://sbcounty.permitrack.com/WAP</a> and State Water Resources Control Board website – <a href="http://www.waterboards.ca.gov/santaana/water_iss/ues/programs/tmdl/index.shtml">http://www.waterboards.ca.gov/santaana/water_iss/ues/programs/tmdl/index.shtml</a></p>	<p>Twin Creek Channel Santa Ana River, Reach 5: None Santa Ana River, Reach 4: Indicator Bacteria Santa Ana River, Reach 3: Indicator Bacteria, Lead Prado Dam: None Santa Ana River, Reach 2: None Santa Ana River, Reach 1: None Pacific Ocean: None</p>
<p><b>Environmentally Sensitive Areas (ESA)</b> Refer to Watershed Mapping Tool – <a href="http://sbcounty.permitrack.com/WAP">http://sbcounty.permitrack.com/WAP</a></p>	<p>n/a</p>
<p><b>Unlined Downstream Water Bodies</b> Refer to Watershed Mapping Tool – <a href="http://sbcounty.permitrack.com/WAP">http://sbcounty.permitrack.com/WAP</a></p>	<p>Twin Creek Channel and Santa Ana River</p>
<p><b>Hydrologic Conditions of Concern</b></p>	<p><input type="checkbox"/> Yes Complete Hydrologic Conditions of Concern (HCOC) Assessment. Include Forms 4.2-2 through Form 4.2-5 and Hydromodification BMP Form 4.3-10 in submittal <input checked="" type="checkbox"/> No</p>
<p><b>Watershed-based BMP included in a RWQCB approved WAP</b></p>	<p><input type="checkbox"/> Yes Attach verification of regional BMP evaluation criteria in WAP</p> <ul style="list-style-type: none"> <li>• More Effective than On-site LID</li> <li>• Remaining Capacity for Project DCV</li> <li>• Upstream of any Water of the US</li> <li>• Operational at Project Completion</li> <li>• Long-Term Maintenance Plan</li> </ul> <p><input checked="" type="checkbox"/> No</p>

## Section 4 Best Management Practices (BMP)

### 4.1 Source Control BMP

#### 4.1.1 Pollution Prevention

Non-structural and structural source control BMP are required to be incorporated into all new development and significant redevelopment projects. Form 4.1-1 and 4.1-2 are used to describe specific source control BMPs used in the WQMP or to explain why a certain BMP is not applicable. Table 7-3 of the TGD for WQMP provides a list of applicable source control BMP for projects with specific types of potential pollutant sources or activities. The source control BMP in this table must be implemented for projects with these specific types of potential pollutant sources or activities.

The preparers of this WQMP have reviewed the source control BMP requirements for new development and significant redevelopment projects. The preparers have also reviewed the specific BMP required for project as specified in Forms 4.1-1 and 4.1-2. All applicable non-structural and structural source control BMP shall be implemented in the project.

<b>Form 4.1-1 Non-Structural Source Control BMPs</b>				
Identifier	Name	Check One		Describe BMP Implementation OR, if not applicable, state reason
		Included	Not Applicable	
N1	Education of Property Owners, Tenants and Occupants on Stormwater BMPs	X		Property owner will familiarize him/herself with the educational materials in Attachment "E" and the contents of the WQMP.
N2	Activity Restrictions	X		No outdoor work areas, processing, storage or wash area. Activities are restricted to only those for which a BMP has been implemented.
N3	Landscape Management BMPs	X		Irrigation must be consistent with San Bernardino's Water Conservation Ordinance. Fertilizer and pesticide usage will be consistent with County Management Guidelines for Use of Fertilizers and Pesticides.
N4	BMP Maintenance	X		BMP maintenance, implementation schedules, and responsible parties are included with each specific BMP narrative.
N5	Title 22 CCR Compliance (How development will comply)		X	No hazardous wastes onsite.
N6	Local Water Quality Ordinances	X		Owner/tenant will be in compliance with Local Water Quality Ordinances.
N7	Spill Contingency Plan	X		Owner/tenant will have a spill contingency plan based on individual site needs.
N8	Underground Storage Tank Compliance		X	No USTs onsite.
N9	Hazardous Materials Disclosure Compliance		X	No hazardous materials onsite.
N10	Uniform Fire Code Implementation	X		Owner will comply with Article 80 of the Uniform Fire Code enforced by the fire protection agency.
N11	Litter/Debris Control Program	X		Contract with their landscape maintenance firm to provide this service during regularly schedule maintenance.
N12	Employee Training	X		The owner will ensure that tenants are also familiar with onsite BMPs and necessary maintenance required of the tenants. Owner will check with City and County at least once a year to obtain new or updated educational materials and provide these materials to tenants. Employees shall be trained to clean up minor spills and participate in ongoing maintenance. The WQMP requires annual employee training and new hires within 2 months.
N13	Housekeeping of Loading Docks	X		Keep all fluids indoors. Clean up spills immediately and keep spills from entering storm drain system. No direct discharges into the storm drain system. Area shall be inspected weekly for proper containment and practices with spills cleaned up immediately and disposed of properly.
N14	Catch Basin Inspection Program	X		Monthly inspection by property owner's designee. Sumps will be vacuumed when sediment or trash becomes 2-inches deep and disposed of properly.
N15	Vacuum Sweeping of Private Streets and Parking Lots	X		All landscape maintenance contractors will be required to sweep up all landscape cuttings, mowings and fertilizer materials off paved areas weekly and dispose of properly. Parking areas and drive ways will be swept monthly by sweeping contractor.

<b>Form 4.1-1 Non-Structural Source Control BMPs</b>				
Identifier	Name	Check One		Describe BMP Implementation OR, if not applicable, state reason
		Included	Not Applicable	
N16	Other Non-structural Measures for Public Agency Projects		X	Not a public agency project.
N17	Comply with all other applicable NDPES permits	X		Will comply with Construction General Permit and Industrial General Permit (may apply for No Exposure Certification/NEC).

**Form 4.1-2 Structural Source Control BMPs**

Identifier	Name	Check One		Describe BMP Implementation OR, if not applicable, state reason
		Included	Not Applicable	
S1	Provide storm drain system stenciling and signage (CASQA New Development BMP Handbook SD-13)	X		“No Dumping – Drains to River” stencils will be applied. Legibility of stencil will be maintained on a yearly basis.
S2	Design and construct outdoor material storage areas to reduce pollution introduction (CASQA New Development BMP Handbook SD-34)		X	No outdoor material storage areas onsite.
S3	Design and construct trash and waste storage areas to reduce pollution introduction (CASQA New Development BMP Handbook SD-32)	X		Paved with an impervious surface, designed not to allow run-on from adjoining areas, designed to divert drainage from adjoining roofs and pavements diverted around the area, screened or walled to prevent off-site transport of trash.
S4	Use efficient irrigation systems & landscape design, water conservation, smart controllers, and source control (Statewide Model Landscape Ordinance; CASQA New Development BMP Handbook SD-12)	X		Irrigation systems shall include shutoff valves triggered by a pressure drop to control water loss in the event of broken sprinkler heads or lines. Timers will be used to avoid over watering and watering cycles and duration shall be adjusted seasonally by the landscape maintenance contractor. The landscaping areas will be grouped with plants that have similar water requirements. Native or drought tolerant species shall also be used where appropriate to reduce excess irrigation runoff and promote surface filtration.
S5	Finish grade of landscaped areas at a minimum of 1-2 inches below top of curb, sidewalk, or pavement	X		Landscaped areas will be depressed in order to increase retention of stormwater/irrigation water and promote infiltration.
S6	Protect slopes and channels and provide energy dissipation (CASQA New Development BMP Handbook SD-10)		X	No onsite channels to protect.
S7	Covered dock areas (CASQA New Development BMP Handbook SD-31)		X	Finished goods being loaded and unloaded at the docks may have the potential to contribute to stormwater pollution in the event of a spill. In lieu of covered docks (which is not practical for a site of this magnitude), a spill contingency plan will be available and employees shall be trained to clean up minor spills and participate in ongoing maintenance. The WQMP requires annual employee training and new hires within 2 months.
S8	Covered maintenance bays with spill containment plans (CASQA New Development BMP Handbook SD-31)		X	No maintenance bays onsite.
S9	Vehicle wash areas with spill containment plans (CASQA New Development BMP Handbook SD-33)		X	No vehicle wash areas onsite.

<b>Form 4.1-2 Structural Source Control BMPs</b>				
Identifier	Name	Check One		Describe BMP Implementation OR, if not applicable, state reason
		Included	Not Applicable	
S10	Covered outdoor processing areas (CASQA New Development BMP Handbook SD-36)		X	No outdoor processing areas onsite.
S11	Equipment wash areas with spill containment plans (CASQA New Development BMP Handbook SD-33)		X	No equipment wash areas onsite.
S12	Fueling areas (CASQA New Development BMP Handbook SD-30)		X	No fueling areas onsite.
S13	Hillside landscaping (CASQA New Development BMP Handbook SD-10)		X	No hillsides onsite.
S14	Wash water control for food preparation areas		X	No food preparation onsite.
S15	Community car wash racks (CASQA New Development BMP Handbook SD-33)		X	No community cars wash racks onsite.

### 4.1.2 Preventive LID Site Design Practices

Site design practices associated with new LID requirements in the MS4 Permit should be considered in the earliest phases of a project. Preventative site design practices can result in smaller DCV for LID BMP and hydromodification control BMP by reducing runoff generation. Describe site design and drainage plan including:

- A narrative of site design practices utilized or rationale for not using practices
- A narrative of how site plan incorporates preventative site design practices
- Include an attached Site Plan layout which shows how preventative site design practices are included in WQMP

Refer to Section 5.2 of the TGD for WQMP for more details.

<b>Form 4.1-3 Preventive LID Site Design Practices Checklist</b>	
<b>Site Design Practices</b> <i>If yes, explain how preventative site design practice is addressed in project site plan. If no, other LID BMPs must be selected to meet targets.</i>	
<b>Minimize impervious areas:</b> <input type="checkbox"/> Yes <input checked="" type="checkbox"/> No	The project will utilize an underground infiltration facility to collect runoff from impervious areas.
<b>Maximize natural infiltration capacity:</b> <input checked="" type="checkbox"/> Yes <input type="checkbox"/> No	The infiltration facility is positioned in areas that will maximize the amount of stormwater collected for treatment.
<b>Preserve existing drainage patterns and time of concentration:</b> <input checked="" type="checkbox"/> Yes <input type="checkbox"/> No	Post-development drainage patterns will mimic pre-development conditions. The infiltration facility will assist in maintaining the existing time of concentration.
<b>Disconnect impervious areas:</b> <input checked="" type="checkbox"/> Yes <input type="checkbox"/> No	The infiltration facility will disconnect impervious areas before discharging offsite.
<b>Protect existing vegetation and sensitive areas:</b> <input type="checkbox"/> Yes <input checked="" type="checkbox"/> No	The project site was previously mass graded. No vegetation or sensitive areas to protect.
<b>Re-vegetate disturbed areas:</b> <input type="checkbox"/> Yes <input checked="" type="checkbox"/> No	Not applicable, development consists of a light industrial facility. Most of the disturbed areas will be paved; however, all disturbed areas will be collected by the infiltration facility for treatment. Landscape will be provided throughout the site.
<b>Minimize unnecessary compaction in stormwater retention/infiltration basin/trench areas:</b> <input checked="" type="checkbox"/> Yes <input type="checkbox"/> No	Heavy construction vehicles will be prohibited from unnecessary soil compaction around the infiltration facility.
<b>Utilize vegetated drainage swales in place of underground piping or imperviously lined swales:</b> <input type="checkbox"/> Yes <input checked="" type="checkbox"/> No	Underground piping is located at truck and car loading areas that could not be substituted with vegetated swales.
<b>Stake off areas that will be used for landscaping to minimize compaction during construction :</b> <input checked="" type="checkbox"/> Yes <input type="checkbox"/> No	Landscaped areas will be staked to minimize unnecessary compaction during construction.



## 4.2 Project Performance Criteria

The purpose of this section of the Project WQMP is to establish targets for post development hydrology based on performance criteria specified in the MS4 Permit. These targets include runoff volume for water quality control (referred to as LID design capture volume), and runoff volume, time of concentration, and peak runoff for protection of any downstream waterbody segments with a HCOC. ***If the project has more than one outlet for stormwater runoff, then complete additional versions of these forms for each DA / outlet.***

Methods applied in the following forms include:

- For LID BMP Design Capture Volume (DCV), the San Bernardino County Stormwater Program requires use of the P6 method (MS4 Permit Section XI.D.6a.ii) – Form 4.2-1
- For HCOC pre- and post-development hydrologic calculation, the San Bernardino County Stormwater Program requires the use of the Rational Method (San Bernardino County Hydrology Manual Section D). Forms 4.2-2 through Form 4.2-5 calculate hydrologic variables including runoff volume, time of concentration, and peak runoff from the project site pre- and post-development using the Hydrology Manual Rational Method approach. For projects greater than 640 acres (1.0 mi<sup>2</sup>), the Rational Method and these forms should not be used. For such projects, the Unit Hydrograph Method (San Bernardino County Hydrology Manual Section E) shall be applied for hydrologic calculations for HCOC performance criteria.

Refer to Section 4 in the TGD for WQMP for detailed guidance and instructions.

<b>Form 4.2-1 LID BMP Performance Criteria for Design Capture Volume (DA 1)</b>		
<sup>1</sup> Project area (ft <sup>2</sup> ): 500,940 (11.50 ac. – DA 1 DMA A)*	<sup>2</sup> Imperviousness after applying preventative site design practices (Imp%): 95%	<sup>3</sup> Runoff Coefficient (R <sub>c</sub> ): 0.807 $R_c = 0.858(\text{Imp}\%)^3 - 0.78(\text{Imp}\%)^2 + 0.774(\text{Imp}\%) + 0.04$
<sup>4</sup> Determine 1-hour rainfall depth for a 2-year return period P <sub>2yr-1hr</sub> (in): 0.500 <a href="http://hdsc.nws.noaa.gov/hdsc/pfds/sa/sca_pfds.html">http://hdsc.nws.noaa.gov/hdsc/pfds/sa/sca_pfds.html</a>		
<sup>5</sup> Compute P6, Mean 6-hr Precipitation (inches): 0.740 P6 = Item 4 * C <sub>1</sub> , where C <sub>1</sub> is a function of site climatic region specified in Form 3-1 Item 1 (Valley = 1.4807; Mountain = 1.909; Desert = 1.2371)		
<sup>6</sup> Drawdown Rate Use 48 hours as the default condition. Selection and use of the 24 hour drawdown time condition is subject to approval by the local jurisdiction. The necessary BMP footprint is a function of drawdown time. While shorter drawdown times reduce the performance criteria for LID BMP design capture volume, the depth of water that can be stored is also reduced.		24-hrs <input type="checkbox"/> 48-hrs <input checked="" type="checkbox"/>
<sup>7</sup> Compute design capture volume, DCV (ft <sup>3</sup> ): 48,958 DCV = 1/12 * [Item 1 * Item 3 * Item 5 * C <sub>2</sub> ], where C <sub>2</sub> is a function of drawdown rate (24-hr = 1.582; 48-hr = 1.963) Compute separate DCV for each outlet from the project site per schematic drawn in Form 3-1 Item 2		

\* This value does not include 0.50 acres of landscape area that does not drain to the proposed LID BMP.

### Form 4.2-2 Summary of HCOC Assessment

Does project have the potential to cause or contribute to an HCOC in a downstream channel: Yes No

Go to: <http://sbcounty.permitrack.com/WAP/>

If "Yes", then complete HCOC assessment of site hydrology for 2yr storm event using Forms 4.2-3 through 4.2-5 and insert results below (Forms 4.2-3 through 4.2-5 may be replaced by computer software analysis based on the San Bernardino County Hydrology Manual)

If "No," then proceed to Section 4.3 Project Conformance Analysis

Condition	Runoff Volume (ft <sup>3</sup> )	Time of Concentration (min)	Peak Runoff (cfs)
<b>Pre-developed</b>	<sup>1</sup> N/A Form 4.2-3 Item 12	<sup>2</sup> N/A Form 4.2-4 Item 13	<sup>3</sup> N/A Form 4.2-5 Item 10
<b>Post-developed</b>	<sup>4</sup> N/A Form 4.2-3 Item 13	<sup>5</sup> N/A Form 4.2-4 Item 14	<sup>6</sup> N/A Form 4.2-5 Item 14
<b>Difference</b>	<sup>7</sup> N/A Item 4 – Item 1	<sup>8</sup> N/A Item 5 – Item 2	<sup>9</sup> N/A Item 6 – Item 3
<b>Difference</b> (as % of pre-developed)	<sup>10</sup> N/A Item 7 / Item 1	<sup>11</sup> N/A Item 8 / Item 2	<sup>12</sup> N/A Item 9 / Item 3

### Form 4.2-3 HCOC Assessment for Runoff Volume

Compute weighted curve number for pre and post developed conditions	Pre-developed DA <i>Add more columns if more than 4 DMA</i>				Post-developed DA <i>Add more columns if more than 4 DMA</i>			
	n/a	n/a	n/a	n/a	n/a	n/a	n/a	n/a
<sup>1</sup> Land Cover type	n/a	n/a	n/a	n/a	n/a	n/a	n/a	n/a
<sup>2</sup> Hydrologic Soil Group (HSG)	n/a	n/a	n/a	n/a	n/a	n/a	n/a	n/a
<sup>3</sup> DMA Area, ft <sup>2</sup> <i>sum of areas of DMA should equal area of DA</i>	n/a	n/a	n/a	n/a	n/a	n/a	n/a	n/a
<sup>4</sup> Curve Number (CN) <i>Use Items 1 and 2 to select the appropriate CN from Appendix C-2 of the TGD for WQMP</i>	n/a	n/a	n/a	n/a	n/a	n/a	n/a	n/a
	<sup>5</sup> Pre-Developed area-weighted CN: N/A				<sup>6</sup> Post-Developed area-weighted CN: N/A			
	<sup>7</sup> Pre-developed soil storage capacity, S (in): N/A <i>S = (1000 / Item 5) - 10</i>				<sup>8</sup> Post-developed soil storage capacity, S (in): N/A <i>S = (1000 / Item 6) - 10</i>			
	<sup>9</sup> Initial abstraction, I <sub>a</sub> (in): N/A <i>I<sub>a</sub> = 0.2 * Item 7</i>				<sup>10</sup> Initial abstraction, I <sub>a</sub> (in): N/A <i>I<sub>a</sub> = 0.2 * Item 8</i>			
<sup>11</sup> Precipitation for 2 yr, 24 hr storm (in): N/A <i>Go to: <a href="http://hdsc.nws.noaa.gov/hdsc/pfds/so/sca_pfds.html">http://hdsc.nws.noaa.gov/hdsc/pfds/so/sca_pfds.html</a></i>								
<sup>12</sup> Pre-developed Volume (ft <sup>3</sup> ): N/A <i>V<sub>pre</sub> = (1 / 12) * (Item sum of Item 3) * [(Item 11 - Item 9)^2 / ((Item 11 - Item 9 + Item 7))]</i>								
<sup>13</sup> Post-developed Volume (ft <sup>3</sup> ): N/A <i>V<sub>pre</sub> = (1 / 12) * (Item sum of Item 3) * [(Item 11 - Item 10)^2 / ((Item 11 - Item 10 + Item 8))]</i>								
<sup>14</sup> Volume Reduction needed to meet HCOC Requirement, (ft <sup>3</sup> ): N/A <i>V<sub>HCOC</sub> = (Item 13 * 0.95) - Item 12</i>								

### Form 4.2-4 HCOC Assessment for Time of Concentration

Compute time of concentration for pre and post developed conditions for each DA (For projects using the Hydrology Manual complete the form below)

Variables	Pre-developed DA <i>Add more columns if more than 4 DMA</i>				Post-developed DA <i>Add more columns if more than 4 DMA</i>		
	n/a	n/a	n/a	n/a	n/a	n/a	n/a
<sup>1</sup> Length of flowpath (ft) <i>Use Form 3-2 Item 5 for pre-developed condition</i>	n/a	n/a	n/a	n/a	n/a	n/a	n/a
<sup>2</sup> Change in elevation (ft)	n/a	n/a	n/a	n/a	n/a	n/a	n/a
<sup>3</sup> Slope (ft/ft), $S_o = \text{Item 2} / \text{Item 1}$	n/a	n/a	n/a	n/a	n/a	n/a	n/a
<sup>4</sup> Land cover	n/a	n/a	n/a	n/a	n/a	n/a	n/a
<sup>5</sup> Initial DMA Time of Concentration (min) <i>Appendix C-1 of the TGD for WQMP</i>	n/a	n/a	n/a	n/a	n/a	n/a	n/a
<sup>6</sup> Length of conveyance from DMA outlet to project site outlet (ft) <i>May be zero if DMA outlet is at project site outlet</i>	n/a	n/a	n/a	n/a	n/a	n/a	n/a
<sup>7</sup> Cross-sectional area of channel (ft <sup>2</sup> )	n/a	n/a	n/a	n/a	n/a	n/a	n/a
<sup>8</sup> Wetted perimeter of channel (ft)	n/a	n/a	n/a	n/a	n/a	n/a	n/a
<sup>9</sup> Manning's roughness of channel (n)	n/a	n/a	n/a	n/a	n/a	n/a	n/a
<sup>10</sup> Channel flow velocity (ft/sec) $V_{fps} = (1.49 / \text{Item 9}) * (\text{Item 7} / \text{Item 8})^{0.67} * (\text{Item 3})^{0.5}$	n/a	n/a	n/a	n/a	n/a	n/a	n/a
<sup>11</sup> Travel time to outlet (min) $T_t = \text{Item 6} / (\text{Item 10} * 60)$	n/a	n/a	n/a	n/a	n/a	n/a	n/a
<sup>12</sup> Total time of concentration (min) $T_c = \text{Item 5} + \text{Item 11}$	n/a	n/a	n/a	n/a	n/a	n/a	n/a
<sup>13</sup> Pre-developed time of concentration (min): N/A <i>Minimum of Item 12 pre-developed DMA</i>							
<sup>14</sup> Post-developed time of concentration (min): N/A <i>Minimum of Item 12 post-developed DMA</i>							
<sup>15</sup> Additional time of concentration needed to meet HCOC requirement (min): N/A $T_{c\text{HCOC}} = (\text{Item 14} * 0.95) - \text{Item 13}$							

### Form 4.2-5 HCOC Assessment for Peak Runoff

**Compute peak runoff for pre and post developed conditions**

Variables	Pre-developed DA <i>Add more columns if more than 3 DMA</i>			Post-developed DA <i>Add more columns if more than 3 DMA</i>		
	n/a	n/a	n/a	n/a	n/a	n/a
<sup>1</sup> <b>Rainfall Intensity for storm duration equal to time of concentration</b> <i><math>I_{peak} = 10^{(LOG Form 4.2-1 Item 4 - 0.6 LOG Form 4.2-4 Item 5 / 60)}</math></i>	n/a	n/a	n/a	n/a	n/a	n/a
<sup>2</sup> <b>Drainage Area of each DMA (ft<sup>2</sup>)</b> <i>For DMA with outlet at project site outlet, include upstream DMA (Using example schematic in Form 3-1, DMA A will include drainage from DMA C)</i>	n/a	n/a	n/a	n/a	n/a	n/a
<sup>3</sup> <b>Ratio of pervious area to total area</b> <i>For DMA with outlet at project site outlet, include upstream DMA (Using example schematic in Form 3-1, DMA A will include drainage from DMA C)</i>	n/a	n/a	n/a	n/a	n/a	n/a
<sup>4</sup> <b>Pervious area infiltration rate (in/hr)</b> <i>Use pervious area CN and antecedent moisture condition with Appendix C-3 of the TGD for WQMP</i>	n/a	n/a	n/a	n/a	n/a	n/a
<sup>5</sup> <b>Maximum loss rate (in/hr)</b> <i><math>F_m = Item 3 * Item 4</math> Use area-weighted <math>F_m</math> from DMA with outlet at project site outlet, include upstream DMA (Using example schematic in Form 3-1, DMA A will include drainage from DMA C)</i>	n/a	n/a	n/a	n/a	n/a	n/a
<sup>6</sup> <b>Peak Flow from DMA (cfs)</b> <i><math>Q_p = Item 2 * 0.9 * (Item 1 - Item 5)</math></i>	n/a	n/a	n/a	n/a	n/a	n/a
<sup>7</sup> <b>Time of concentration adjustment factor for other DMA to site discharge point</b> <i>Form 4.2-4 Item 12 DMA / Other DMA upstream of site discharge point (If ratio is greater than 1.0, then use maximum value of 1.0)</i>	<b>DMA A</b>	n/a		n/a		
	<b>DMA B</b>		n/a		n/a	
	<b>DMA C</b>			n/a		n/a
<sup>8</sup> <b>Pre-developed <math>Q_p</math> at <math>T_c</math> for DMA A:</b> <i><math>Q_p = Item 6_{DMAA} + [Item 6_{DMAB} * (Item 1_{DMAA} - Item 5_{DMAB}) / (Item 1_{DMAB} - Item 5_{DMAB}) * Item 7_{DMAA/2}] + [Item 6_{DMAC} * (Item 1_{DMAA} - Item 5_{DMAC}) / (Item 1_{DMAC} - Item 5_{DMAC}) * Item 7_{DMAA/3}]</math></i>	<sup>9</sup> <b>Pre-developed <math>Q_p</math> at <math>T_c</math> for DMA B:</b> <i><math>Q_p = Item 6_{DMAB} + [Item 6_{DMAA} * (Item 1_{DMAB} - Item 5_{DMAA}) / (Item 1_{DMAA} - Item 5_{DMAA}) * Item 7_{DMAB/1}] + [Item 6_{DMAC} * (Item 1_{DMAB} - Item 5_{DMAC}) / (Item 1_{DMAC} - Item 5_{DMAC}) * Item 7_{DMAB/3}]</math></i>			<sup>10</sup> <b>Pre-developed <math>Q_p</math> at <math>T_c</math> for DMA C:</b> <i><math>Q_p = Item 6_{DMAC} + [Item 6_{DMAA} * (Item 1_{DMAC} - Item 5_{DMAA}) / (Item 1_{DMAA} - Item 5_{DMAA}) * Item 7_{DMAC/1}] + [Item 6_{DMAB} * (Item 1_{DMAC} - Item 5_{DMAB}) / (Item 1_{DMAB} - Item 5_{DMAB}) * Item 7_{DMAC/2}]</math></i>		
<sup>11</sup> <b>Peak runoff from pre-developed condition confluence analysis (cfs): N/A</b> <i>Maximum of Item 8, 9, and 10</i>						
<sup>12</sup> <b>Post-developed <math>Q_p</math> at <math>T_c</math> for DMA A:</b> <i>Same as Item 8 for post-developed values</i>	<sup>13</sup> <b>Post-developed <math>Q_p</math> at <math>T_c</math> for DMA B:</b> <i>Same as Item 9 for post-developed values</i>			<sup>14</sup> <b>Post-developed <math>Q_p</math> at <math>T_c</math> for DMA C:</b> <i>Same as Item 10 for post-developed values</i>		
<sup>15</sup> <b>Peak runoff from post-developed condition confluence analysis (cfs): N/A</b> <i>Maximum of Item 12, 13, and 14</i>						
<sup>16</sup> <b>Peak runoff reduction needed to meet HCOC Requirement (cfs): N/A</b> <i><math>Q_{p-HCOC} = (Item 14 * 0.95) - Item 11</math></i>						

## 4.3 Project Conformance Analysis

Complete the following forms for each project site DA to document that the proposed LID BMPs conform to the project DCV developed to meet performance criteria specified in the MS4 Permit (WQMP Template Section 4.2). For the LID DCV, the forms are ordered according to hierarchy of BMP selection as required by the MS4 Permit (see Section 5.3.1 in the TGD for WQMP). The forms compute the following for on-site LID BMP:

- Site Design and Hydrologic Source Controls (Form 4.3-2)
- Retention and Infiltration (Form 4.3-3)
- Harvested and Use (Form 4.3-4) or
- Biotreatment (Form 4.3-5).

At the end of each form, additional fields facilitate the determination of the extent of mitigation provided by the specific BMP category, allowing for use of the next category of BMP in the hierarchy, if necessary.

The first step in the analysis, using Section 5.3.2.1 of the TGD for WQMP, is to complete Forms 4.3-1 and 4.3-3) to determine if retention and infiltration BMPs are infeasible for the project. For each feasibility criterion in Form 4.3-1, if the answer is “Yes,” provide all study findings that includes relevant calculations, maps, data sources, etc. used to make the determination of infeasibility.

Next, complete Forms 4.3-2 and 4.3-4 to determine the feasibility of applicable HSC and harvest and use BMPs, and, if their implementation is feasible, the extent of mitigation of the DCV.

If no site constraints exist that would limit the type of BMP to be implemented in a DA, evaluate the use of combinations of LID BMPs, including all applicable HSC BMPs to maximize on-site retention of the DCV. If no combination of BMP can mitigate the entire DCV, implement the single BMP type, or combination of BMP types, that maximizes on-site retention of the DCV within the minimum effective area.

If the combination of LID HSC, retention and infiltration, and harvest and use BMPs are unable to mitigate the entire DCV, then biotreatment BMPs may be implemented by the project proponent. If biotreatment BMPs are used, then they must be sized to provide sufficient capacity for effective treatment of the remainder of the volume-based performance criteria that cannot be achieved with LID BMPs (TGD for WQMP Section 5.4.4.2). Under no circumstances shall any portion of the DCV be released from the site without effective mitigation and/or treatment.

## Form 4.3-1 Infiltration BMP Feasibility

Feasibility Criterion – Complete evaluation for each DA on the Project Site

**<sup>1</sup> Would infiltration BMP pose significant risk for groundwater related concerns?** Yes No

*Refer to Section 5.3.2.1 of the TGD for WQMP*

If Yes, Provide basis: (attach)

**<sup>2</sup> Would installation of infiltration BMP significantly increase the risk of geotechnical hazards?** Yes No

*(Yes, if the answer to any of the following questions is yes, as established by a geotechnical expert):*

- *The location is less than 50 feet away from slopes steeper than 15 percent*
- *The location is less than eight feet from building foundations or an alternative setback.*
- *A study certified by a geotechnical professional or an available watershed study determines that stormwater infiltration would result in significantly increased risks of geotechnical hazards.*

If Yes, Provide basis: (attach)

**<sup>3</sup> Would infiltration of runoff on a Project site violate downstream water rights?** Yes No

If Yes, Provide basis: (attach)

**<sup>4</sup> Is proposed infiltration facility located on hydrologic soil group (HSG) D soils or does the site geotechnical investigation indicate presence of soil characteristics, which support categorization as D soils?** Yes No

If Yes, Provide basis: (attach)

**<sup>5</sup> Is the design infiltration rate, after accounting for safety factor of 2.0, below proposed facility less than 0.3 in/hr (accounting for soil amendments)?** Yes No

If Yes, Provide basis: (attach)

**<sup>6</sup> Would on-site infiltration or reduction of runoff over pre-developed conditions be partially or fully inconsistent with watershed management strategies as defined in the WAP, or impair beneficial uses?** Yes No

*See Section 3.5 of the TGD for WQMP and WAP*

If Yes, Provide basis: (attach)

**<sup>7</sup> Any answer from Item 1 through Item 3 is “Yes”:** Yes No

*If yes, infiltration of any volume is not feasible onsite. Proceed to Form 4.3-4, Harvest and Use BMP. If no, then proceed to Item 9 below.*

**<sup>8</sup> Any answer from Item 4 through Item 6 is “Yes”:** Yes No

*If yes, infiltration is permissible but is not required to be considered. Proceed to Form 4.3-2, Hydrologic Source Control BMP.*

*If no, then proceed to Item 9, below.*

**<sup>9</sup> All answers to Item 1 through Item 6 are “No”:** Yes No

*Infiltration of the full DCV is potentially feasible, LID infiltration BMP must be designed to infiltrate the full DCV to the MEP.*

*Proceed to Form 4.3-2, Hydrologic Source Control BMP.*

### 4.3.1 Site Design Hydrologic Source Control BMP

Section XI.E. of the Permit emphasizes the use of LID preventative measures; and the use of LID HSC BMPs reduces the portion of the DCV that must be addressed in downstream BMPs. Therefore, all applicable HSC shall be provided except where they are mutually exclusive with each other, or with other BMPs. Mutual exclusivity may result from overlapping BMP footprints such that either would be potentially feasible by itself, but both could not be implemented. Please note that while there are no numeric standards regarding the use of HSC, if a project cannot feasibly meet BMP sizing requirements or cannot fully address HCOCs, feasibility of all applicable HSC must be part of demonstrating that the BMP system has been designed to retain the maximum feasible portion of the DCV. Complete Form 4.3-2 to identify and calculate estimated retention volume from implementing site design HSC BMP. Refer to Section 5.4.1 in the TGD for more detailed guidance.



<b>Form 4.3-2 Site Design Hydrologic Source Control BMPs</b>			
<b>1 Implementation of Impervious Area Dispersion BMP (i.e. routing runoff from impervious to pervious areas), excluding impervious areas planned for routing to on-lot infiltration BMP):</b> <input type="checkbox"/> Yes <input checked="" type="checkbox"/> No <i>If yes, complete Items 2-5; If no, proceed to Item 6</i>			
<b>Variables</b> <i>Aggregate impervious area dispersion with equal ratios of pervious to impervious;</i>	<b>BMP Type and DA</b>	<b>BMP Type and DA</b>	<b>BMP Type and DA</b>
<b>2 Total impervious area draining to pervious area</b>			
<b>3 Ratio of pervious area receiving runoff to impervious area</b>			
<b>4 Retention volume achieved from impervious area dispersion (ft<sup>3</sup>)</b> <i>V = Item 2 * Item 3 * (0.5/12), assuming retention of 0.5 inches of runoff</i>			
<b>5 Sum of retention volume achieved from impervious area dispersion (ft<sup>3</sup>): 0</b> <i>V<sub>retention</sub> = Sum of Item 4 for all BMPs</i>			
<b>6 Implementation of Localized On-lot Infiltration BMPs (e.g. on-lot rain gardens):</b> <input type="checkbox"/> Yes <input checked="" type="checkbox"/> No <i>If yes, complete Items 7-13 for aggregate of all on-lot infiltration BMP in each DA; If no, proceed to Item 14</i>	<b>BMP Type and DA</b>	<b>BMP Type and DA</b>	<b>BMP Type and DA</b>
<b>7 Ponding surface area (ft<sup>2</sup>)</b>			
<b>8 Ponding depth (ft)</b>			
<b>9 Surface area of amended soil/gravel (ft<sup>2</sup>)</b>			
<b>10 Average depth of amended soil/gravel (ft)</b>			
<b>11 Average porosity of amended soil/gravel</b>			
<b>12 Retention volume achieved from on-lot infiltration (ft<sup>3</sup>)</b> <i>V<sub>retention</sub> = (Item 7 * Item 8) + (Item 9 * Item 10 * Item 11)</i>			
<b>13 Runoff volume retention from on-lot infiltration (ft<sup>3</sup>): 0</b> <i>V<sub>retention</sub> = Sum of Item 12 for all BMPs</i>			
<b>14 Implementation of evapotranspiration BMP (green, brown, or blue roofs):</b> <input type="checkbox"/> Yes <input checked="" type="checkbox"/> No <i>If yes, complete Items 15-20. If no, proceed to Item 21</i>	<b>BMP Type and DA</b>	<b>BMP Type and DA</b>	<b>BMP Type and DA</b>
<b>15 Rooftop area planned for ET BMP (ft<sup>2</sup>)</b>			
<b>16 Average wet season ET demand (in/day)</b> <i>Use local values, typical ~ 0.1</i>			
<b>17 Daily ET demand (ft<sup>3</sup>/day)</b> <i>Item 15 * (Item 16 / 12)</i>			
<b>18 Drawdown time (hrs)</b> <i>Copy Item 6 in Form 4.2-1</i>			
<b>19 Retention Volume (ft<sup>3</sup>)</b> <i>V<sub>retention</sub> = Item 17 * (Item 18 / 24)</i>			
<b>20 Runoff volume retention from evapotranspiration BMPs (ft<sup>3</sup>): 0</b> <i>V = Sum of Item 19 for all BMPs</i>			
<b>21 Implementation of Street Trees:</b> <input type="checkbox"/> Yes <input checked="" type="checkbox"/> No <i>If yes, complete Items 20-2. If no, proceed to Item 26</i>	<b>BMP Type and DA</b>	<b>BMP Type and DA</b>	<b>BMP Type and DA</b>
<b>22 Number of Street Trees</b>			
<b>23 Average canopy cover over impervious area (ft<sup>2</sup>)</b>			
<b>24 Runoff volume retention from street trees (ft<sup>3</sup>)</b> <i>V<sub>retention</sub> = Item 22 * Item 23 * (0.05/12) assume runoff retention of 0.05 inches</i>			
<b>25 Runoff volume retention from street tree BMPs (ft<sup>3</sup>): 0</b> <i>V<sub>retention</sub> = Sum of Item 24 for all BMPs</i>			
<b>26 Implementation of residential rain barrels/cisterns:</b> <input type="checkbox"/> Yes <input checked="" type="checkbox"/> No <i>If yes, complete Items 27-28; If no, proceed to Item 30</i>	<b>BMP Type and DA</b>	<b>BMP Type and DA</b>	<b>BMP Type and DA</b>
<b>27 Number of rain barrels/cisterns</b>			
<b>28 Runoff volume retention from rain barrels/cisterns (ft<sup>3</sup>)</b> <i>V<sub>retention</sub> = Item 27 * 3</i>			
<b>29 Runoff volume retention from residential rain barrels/Cisterns (ft<sup>3</sup>): 0</b> <i>V<sub>retention</sub> = Sum of Item 28 for all BMPs</i>			
<b>30 Total Retention Volume from Site Design Hydrologic Source Control BMPs: 0</b> <i>Sum of Items 5, 13, 20, 25 and 29</i>			

### 4.3.2 Infiltration BMPs

Use Form 4.3-3 to compute on-site retention of runoff from proposed retention and infiltration BMPs. Volume retention estimates are sensitive to the percolation rate used, which determines the amount of runoff that can be infiltrated within the specified drawdown time. The infiltration safety factor reduces field measured percolation to account for potential inaccuracy associated with field measurements, declining BMP performance over time, and compaction during construction. Appendix D of the TGD for WQMP provides guidance on estimating an appropriate safety factor to use in Form 4.3-3.

If site constraints limit the use of BMPs to a single type and implementation of retention and infiltration BMPs mitigate no more than 40% of the DCV, then they are considered infeasible and the Project Proponent may evaluate the effectiveness of BMPs lower in the LID hierarchy of use (Section 5.5.1 of the TGD for WQMP)

If implementation of infiltrations BMPs is feasible as determined using Form 4.3-1, then LID infiltration BMPs shall be implemented to the MEP (section 4.1 of the TGD for WQMP).

### Form 4.3-3 Infiltration LID BMP (including underground BMPs)

<sup>1</sup> Remaining LID DCV not met by site design HSC BMP (ft<sup>3</sup>): 48,958

*V = Form 4.2-1 Item 7 - Form 4.3-2 Item 30*

BMP Type <i>Use columns to the right to compute runoff volume retention from proposed infiltration BMP (select BMP from Table 5-4 in TGD for WQMP)</i>	DA 1 DMA A Underground Chambers	n/a	n/a	n/a	n/a
<sup>2</sup> Infiltration rate of underlying soils (in/hr) <i>See Section 5.4.2 and Appendix D of the TGD for WQMP for minimum requirements for assessment methods</i>	2.80	n/a	n/a	n/a	n/a
<sup>3</sup> Infiltration safety factor <i>See TGD Section 5.4.2 and Appendix D</i>	2.00	n/a	n/a	n/a	n/a
<sup>4</sup> Design percolation rate (in/hr) <i>P<sub>design</sub> = Item 2 / Item 3</i>	1.40	n/a	n/a	n/a	n/a
<sup>5</sup> Ponded water drawdown time (hr) <i>Copy Item 6 in Form 4.2-1</i>	48	n/a	n/a	n/a	n/a
<sup>6</sup> Maximum ponding depth (ft) <i>BMP specific, see Table 5-4 of the TGD for WQMP for BMP design details</i>	5.15' (61.8")	n/a	n/a	n/a	n/a
<sup>7</sup> Ponding Depth (ft) <i>d<sub>BMP</sub> = Minimum of (1/12 * Item 4 * Item 5) or Item 6</i>	5.15' (61.8")	n/a	n/a	n/a	n/a
<sup>8</sup> Infiltrating surface area, SA (ft <sup>2</sup> ) <i>The lesser of the area needed for BMP infiltration of full DCV or minimum space requirements from Table 5-7 of the TGD for WQMP</i>	12,038	n/a	n/a	n/a	n/a
<sup>9</sup> Amended soil depth, d <sub>media</sub> (ft) <i>Only included in certain BMP types, see Table 5-4 in the TGD for WQMP for reference to BMP design details</i>	n/a	n/a	n/a	n/a	n/a
<sup>10</sup> Amended soil porosity	n/a	n/a	n/a	n/a	n/a
<sup>11</sup> Gravel depth, d <sub>media</sub> (ft) <i>Only included in certain BMP types, see Table 5-4 of the TGD for WQMP for BMP design details</i>	2.5	n/a	n/a	n/a	n/a
<sup>12</sup> Gravel porosity	0.40	n/a	n/a	n/a	n/a
<sup>13</sup> Duration of storm as basin is filling (hrs) <i>Typical ~ 3hrs</i>	3	n/a	n/a	n/a	n/a
<sup>14</sup> Above Ground Retention Volume (ft <sup>3</sup> ) <i>V<sub>retention</sub> = Item 8 * [Item 7 + (Item 9 retention * Item 10) + (Item 11 * Item 12) + (Item 13 * (Item 4 / 12))]</i>	n/a	n/a	n/a	n/a	n/a
<sup>15</sup> Underground Retention Volume (ft <sup>3</sup> ) <i>Volume determined using manufacturer's specifications and calculations</i>	48,962	n/a	n/a	n/a	n/a
<sup>16</sup> Total Retention Volume from LID Infiltration BMPs (ft <sup>3</sup> ): 48,962 <i>(Sum of Items 14 and 15 for all infiltration BMP included in plan)</i>					
<sup>17</sup> Fraction of DCV achieved with infiltration BMP: 100% <i>Retention% = Item 16 / Form 4.2-1 Item 7</i>					
<sup>18</sup> Is full LID DCV retained on-site with combination of hydrologic source control and LID retention and infiltration BMPs? <input checked="" type="checkbox"/> Yes <input type="checkbox"/> No <i>If yes, demonstrate conformance using Form 4.3-10; If no, then reduce Item 3, Factor of Safety to 2.0 and increase Item 8, Infiltrating Surface Area, such that the portion of the site area used for retention and infiltration BMPs equals or exceeds the minimum effective area thresholds (Table 5-7 of the TGD for WQMP) for the applicable category of development and repeat all above calculations.</i>					

### 4.3.3 Harvest and Use BMP

Harvest and use BMP may be considered if the full LID DCV cannot be met by maximizing infiltration BMPs. Use Form 4.3-4 to compute on-site retention of runoff from proposed harvest and use BMPs.

Volume retention estimates for harvest and use BMPs are sensitive to the on-site demand for captured stormwater. Since irrigation water demand is low in the wet season, when most rainfall events occur in San Bernardino County, the volume of water that can be used within a specified drawdown period is relatively low. The bottom portion of Form 4.3-4 facilitates the necessary computations to show infeasibility if a minimum incremental benefit of 40 percent of the LID DCV would not be achievable with MEP implementation of on-site harvest and use of stormwater (Section 5.5.4 of the TGD for WQMP).

<b>Form 4.3-4 Harvest and Use BMPs</b>			
<sup>1</sup> Remaining LID DCV not met by site design HSC or infiltration BMP (ft <sup>3</sup> ): $V_{unmet} = \text{Form 4.2-1 Item 7} - \text{Form 4.3-2 Item 30} - \text{Form 4.3-3 Item 16}$			
<b>BMP Type(s)</b> <i>Compute runoff volume retention from proposed harvest and use BMP (Select BMPs from Table 5-4 of the TGD for WQMP)</i>	<b>BMP Type and DA</b>	<b>BMP Type and DA</b>	<b>BMP Type and DA</b>
<sup>2</sup> Describe cistern or runoff detention facility			
<sup>3</sup> Storage volume for proposed detention type (ft <sup>3</sup> ) <i>Volume of cistern</i>			
<sup>4</sup> Landscaped area planned for use of harvested stormwater (ft <sup>2</sup> )			
<sup>5</sup> Average wet season daily irrigation demand (in/day) <i>Use local values, typical ~ 0.1 in/day</i>			
<sup>6</sup> Daily water demand (ft <sup>3</sup> /day) <i>Item 4 * (Item 5 / 12)</i>			
<sup>7</sup> Drawdown time (hrs) <i>Copy Item 6 from Form 4.2-1</i>			
<sup>8</sup> Retention Volume (ft <sup>3</sup> ) <i><math>V_{retention} = \text{Minimum of (Item 3) or (Item 6 * (Item 7 / 24))}</math></i>			
<sup>9</sup> Total Retention Volume (ft <sup>3</sup> ) from Harvest and Use BMP: <i>Sum of Item 8 for all harvest and use BMP included in plan</i>			
<sup>10</sup> Is the full DCV retained with a combination of LID HSC, retention and infiltration, and harvest and use BMPs? <input type="checkbox"/> Yes <input type="checkbox"/> No <i>If yes, demonstrate conformance using Form 4.3-10. If no, then re-evaluate combinations of all LID BMP and optimize their implementation such that the maximum portion of the DCV is retained on-site (using a single BMP type or combination of BMP types). If the full DCV cannot be mitigated after this optimization process, proceed to Section 4.3.4.</i>			

### 4.3.4 Biotreatment BMP

Biotreatment BMPs may be considered if the full LID DCV cannot be met by maximizing retention and infiltration, and harvest and use BMPs. A key consideration when using biotreatment BMP is the effectiveness of the proposed BMP in addressing the pollutants of concern for the project (see Table 5-5 of the TGD for WQMP).

Use Form 4.3-5 to summarize the potential for volume based and/or flow based biotreatment options to biotreat the remaining unmet LID DCV. Biotreatment computations are included as follows:

- Use Form 4.3-6 to compute biotreatment in small volume based biotreatment BMP (e.g. bioretention w/underdrains);
- Use Form 4.3-7 to compute biotreatment in large volume based biotreatment BMP (e.g. constructed wetlands);
- Use Form 4.3-8 to compute sizing criteria for flow-based biotreatment BMP (e.g. bioswales)

<b>Form 4.3-5 Selection and Evaluation of Biotreatment BMP</b>		
<sup>1</sup> Remaining LID DCV not met by site design HSC, infiltration, or harvest and use BMP for potential biotreatment (ft <sup>3</sup> ): <i>Form 4.2-1 Item 7 – Form 4.3-2 Item 30 – Form 4.3-3 Item 16- Form 4.3-4 Item 9</i>	<b>List pollutants of concern</b> <i>Copy from Form 2.3-1</i>	
<sup>2</sup> Biotreatment BMP Selected <i>(Select biotreatment BMP(s) necessary to ensure all pollutants of concern are addressed through Unit Operations and Processes, described in Table 5-5 of the TGD for WQMP)</i>	<b>Volume-based biotreatment</b> <i>Use Forms 4.3-6 and 4.3-7 to compute treated volume</i>  <input type="checkbox"/> Bioretention with underdrain <input type="checkbox"/> Planter box with underdrain <input type="checkbox"/> Constructed wetlands <input type="checkbox"/> Wet extended detention <input type="checkbox"/> Dry extended detention	<b>Flow-based biotreatment</b> <i>Use Form 4.3-8 to compute treated volume</i>  <input type="checkbox"/> Vegetated swale <input type="checkbox"/> Vegetated filter strip <input type="checkbox"/> Proprietary biotreatment
<sup>3</sup> Volume biotreated in volume based biotreatment BMP (ft <sup>3</sup> ): <i>Form 4.3-6 Item 15 + Form 4.3-7 Item 13</i>	<sup>4</sup> Compute remaining LID DCV with implementation of volume based biotreatment BMP (ft <sup>3</sup> ): <i>Item 1 – Item 3</i>	<sup>5</sup> Remaining fraction of LID DCV for sizing flow based biotreatment BMP: % <i>Item 4 / Item 1</i>
<sup>6</sup> Flow-based biotreatment BMP capacity provided (cfs): <i>Use Figure 5-2 of the TGD for WQMP to determine flow capacity required to provide biotreatment of remaining percentage of unmet LID DCV (Item 5), for the project's precipitation zone (Form 3-1 Item 1)</i>		
<sup>7</sup> Metrics for MEP determination: <input type="checkbox"/> Provided a WQMP with the portion of site area used for suite of LID BMP equal to minimum thresholds in Table 5-7 of the TGD for WQMP for the proposed category of development: <i>If maximized on-site retention BMPs is feasible for partial capture, then LID BMP implementation must be optimized to retain and infiltrate the maximum portion of the DCV possible within the prescribed minimum effective area. The remaining portion of the DCV shall then be mitigated using biotreatment BMP.</i>		

<b>Form 4.3-6 Volume Based Biotreatment – Bioretention and Planter Boxes with Underdrains</b>			
<b>BMP Type(s)</b> <i>Compute runoff volume retention from proposed harvest and use BMP (Select BMPs from Table 5-4 of the TGD for WQMP)</i>	<b>BMP Type and DA</b>	<b>BMP Type and DA</b>	<b>BMP Type and DA</b>
<b><sup>1</sup> Pollutants addressed with BMP</b> <i>List all pollutant of concern that will be effectively reduced through specific Unit Operations and Processes described in Table 5-5 of the TGD for WQMP</i>			
<b><sup>2</sup> Amended soil infiltration rate</b> <i>Typical ~ 5.0 in/hr</i>			
<b><sup>3</sup> Amended soil infiltration safety factor</b> <i>Typical ~ 2.0</i>			
<b><sup>4</sup> Amended soil design percolation rate (in/hr)</b> <i><math>P_{design} = \text{Item 2} / \text{Item 3}</math></i>			
<b><sup>5</sup> Pondered water drawdown time (hr)</b> <i>Copy Item 6 from Form 4.2-1</i>			
<b><sup>6</sup> Maximum ponding depth (ft)</b> <i>See Table 5-6 of the TGD for WQMP for reference to BMP design details</i>			
<b><sup>7</sup> Ponding Depth (ft)</b> <i><math>d_{BMP} = \text{Minimum of } (1/12 * \text{Item 4} * \text{Item 5}) \text{ or Item 6}</math></i>			
<b><sup>8</sup> Amended soil surface area (ft<sup>2</sup>)</b>			
<b><sup>9</sup> Amended soil depth (ft)</b> <i>See Table 5-6 of the TGD for WQMP for reference to BMP design details</i>			
<b><sup>10</sup> Amended soil porosity, <i>n</i></b>			
<b><sup>11</sup> Gravel depth (ft)</b> <i>See Table 5-6 of the TGD for WQMP for reference to BMP design details</i>			
<b><sup>12</sup> Gravel porosity, <i>n</i></b>			
<b><sup>13</sup> Duration of storm as basin is filling (hrs)</b> <i>Typical ~ 3hrs</i>			
<b><sup>14</sup> Biotreated Volume (ft<sup>3</sup>)</b> <i><math>V_{biotreated} = \text{Item 8} * [( \text{Item 7} / 2 ) + ( \text{Item 9} * \text{Item 10} ) + ( \text{Item 11} * \text{Item 12} ) + ( \text{Item 13} * ( \text{Item 4} / 12 ) )]</math></i>			
<b><sup>15</sup> Total biotreated volume from bioretention and/or planter box with underdrains BMP:</b> <i>Sum of Item 14 for all volume-based BMPs included in this form</i>			

## Form 4.3-7 Volume Based Biotreatment – Constructed Wetlands and Extended Detention

<b>Biotreatment BMP Type</b> <i>Constructed wetlands, extended wet detention, extended dry detention, or other comparable proprietary BMP. If BMP includes multiple modules (e.g. forebay and main basin), provide separate estimates for storage and pollutants treated in each module.</i>	<b>BMP Type and DA</b>		<b>BMP Type and DA</b>		<b>BMP Type and DA</b>	
	<b>Forebay</b>	<b>Basin</b>	<b>Forebay</b>	<b>Basin</b>	<b>Forebay</b>	<b>Basin</b>
<b><sup>1</sup> Pollutants addressed with BMP forebay and basin</b> <i>List all pollutant of concern that will be effectively reduced through specific Unit Operations and Processes described in Table 5-5 of the TGD for WQMP</i>						
<b><sup>2</sup> Bottom width (ft)</b>						
<b><sup>3</sup> Bottom length (ft)</b>						
<b><sup>4</sup> Bottom area (ft<sup>2</sup>)</b> <i>A<sub>bottom</sub> = Item 2 * Item 3</i>						
<b><sup>5</sup> Side slope (ft/ft)</b>						
<b><sup>6</sup> Depth of storage (ft)</b>						
<b><sup>7</sup> Water surface area (ft<sup>2</sup>)</b> <i>A<sub>surface</sub> = (Item 2 + (2 * Item 5 * Item 6)) * (Item 3 + (2 * Item 5 * Item 6))</i>						
<b><sup>8</sup> Storage volume (ft<sup>3</sup>)</b> <i>For BMP with a forebay, ensure fraction of total storage is within ranges specified in BMP specific fact sheets, see Table 5-6 of the TGD for WQMP for reference to BMP design details V = Item 6 / 3 * [Item 4 + Item 7 + (Item 4 * Item 7)<sup>0.5</sup>]</i>						
<b><sup>9</sup> Drawdown Time (hrs)</b> <i>Copy Item 6 from Form 2.1</i>						
<b><sup>10</sup> Outflow rate (cfs)</b> <i>Q<sub>BMP</sub> = (Item 8<sub>forebay</sub> + Item 8<sub>basin</sub>) / (Item 9 * 3600)</i>						
<b><sup>11</sup> Duration of design storm event (hrs)</b>						
<b><sup>12</sup> Biotreated Volume (ft<sup>3</sup>)</b> <i>V<sub>biotreated</sub> = (Item 8<sub>forebay</sub> + Item 8<sub>basin</sub>) + (Item 10 * Item 11 * 3600)</i>						
<b><sup>13</sup> Total biotreated volume from constructed wetlands, extended dry detention, or extended wet detention:</b> <i>(Sum of Item 12 for all BMP included in plan)</i>						

<b>Form 4.3-8 Flow Based Biotreatment</b>			
<b>Biotreatment BMP Type</b> <i>Vegetated swale, vegetated filter strip, or other comparable proprietary BMP</i>	<b>BMP Type and DA</b>	<b>BMP Type and DA</b>	<b>BMP Type and DA</b>
<b><sup>1</sup> Pollutants addressed with BMP</b> <i>List all pollutant of concern that will be effectively reduced through specific Unit Operations and Processes described in TGD Table 5-5</i>			
<b><sup>2</sup> Flow depth for water quality treatment (ft)</b> <i>BMP specific, see Table 5-6 of the TGD for WQMP for reference to BMP design details</i>			
<b><sup>3</sup> Bed slope (ft/ft)</b> <i>BMP specific, see Table 5-6 of the TGD for WQMP for reference to BMP design details</i>			
<b><sup>4</sup> Manning's roughness coefficient</b>			
<b><sup>5</sup> Bottom width (ft)</b> <i><math>b_w = (\text{Form 4.3-5 Item 6} * \text{Item 4}) / (1.49 * \text{Item 2}^{1.67} * \text{Item 3}^{0.5})</math></i>			
<b><sup>6</sup> Side Slope (ft/ft)</b> <i>BMP specific, see Table 5-6 of the TGD for WQMP for reference to BMP design details</i>			
<b><sup>7</sup> Cross sectional area (ft<sup>2</sup>)</b> <i><math>A = (\text{Item 5} * \text{Item 2}) + (\text{Item 6} * \text{Item 2}^2)</math></i>			
<b><sup>8</sup> Water quality flow velocity (ft/sec)</b> <i><math>V = \text{Form 4.3-5 Item 6} / \text{Item 7}</math></i>			
<b><sup>9</sup> Hydraulic residence time (min)</b> <i>Pollutant specific, see Table 5-6 of the TGD for WQMP for reference to BMP design details</i>			
<b><sup>10</sup> Length of flow based BMP (ft)</b> <i><math>L = \text{Item 8} * \text{Item 9} * 60</math></i>			
<b><sup>11</sup> Water surface area at water quality flow depth (ft<sup>2</sup>)</b> <i><math>SA_{top} = (\text{Item 5} + (2 * \text{Item 2} * \text{Item 6})) * \text{Item 10}</math></i>			



### 4.3.5 Conformance Summary

Complete Form 4.3-9 to demonstrate how on-site LID DCV is met with proposed site design hydrologic source control, infiltration, harvest and use, and/or biotreatment BMP. The bottom line of the form is used to describe the basis for infeasibility determination for on-site LID BMP to achieve full LID DCV, and provides methods for computing remaining volume to be addressed in an alternative compliance plan. If the project has more than one outlet, then complete additional versions of this form for each outlet.

Form 4.3-9 Conformance Summary and Alternative Compliance Volume Estimate
<sup>1</sup> <b>Total LID DCV for the Project (ft<sup>3</sup>):</b> 48,958 <i>Copy Item 7 in Form 4.2-1</i>
<sup>2</sup> <b>On-site retention with site design hydrologic source control LID BMP (ft<sup>3</sup>):</b> 0 <i>Copy Item 30 in Form 4.3-2</i>
<sup>3</sup> <b>On-site retention with LID infiltration BMP (ft<sup>3</sup>):</b> 48,962 <i>Copy Item 16 in Form 4.3-3</i>
<sup>4</sup> <b>On-site retention with LID harvest and use BMP (ft<sup>3</sup>):</b> 0 <i>Copy Item 9 in Form 4.3-4</i>
<sup>5</sup> <b>On-site biotreatment with volume based biotreatment BMP (ft<sup>3</sup>):</b> 0 <i>Copy Item 3 in Form 4.3-5</i>
<sup>6</sup> <b>Flow capacity provided by flow based biotreatment BMP (cfs):</b> 0 <i>Copy Item 6 in Form 4.3-5</i>
<sup>7</sup> <b>LID BMP performance criteria are achieved if answer to any of the following is "Yes":</b> <ul style="list-style-type: none"> <li>• <b>Full retention of LID DCV with site design HSC, infiltration, or harvest and use BMP:</b> <input checked="" type="checkbox"/>Yes <input type="checkbox"/>No  <i>If yes, sum of Items 2, 3, and 4 is greater than Item 1</i></li> <li>• <b>Combination of on-site retention BMPs for a portion of the LID DCV and volume-based biotreatment BMP that address all pollutants of concern for the remaining LID DCV:</b> <input type="checkbox"/>Yes <input checked="" type="checkbox"/>No  <i>If yes, a) sum of Items 2, 3, 4, and 5 is greater than Item 1, and Items 2, 3 and 4 are maximized; or b) Item 6 is greater than Form 4.3-5 Item 6 and Items 2, 3 and 4 are maximized</i></li> <li>• <b>On-site retention and infiltration is determined to be infeasible and biotreatment BMP provide biotreatment for all pollutants of concern for full LID DCV:</b> <input type="checkbox"/>Yes <input checked="" type="checkbox"/>No  <i>If yes, Form 4.3-1 Items 7 and 8 were both checked yes</i></li> </ul>
<sup>8</sup> <b>If the LID DCV is not achieved by any of these means, then the project may be allowed to develop an alternative compliance plan. Check box that describes the scenario which caused the need for alternative compliance:</b> <ul style="list-style-type: none"> <li><input type="checkbox"/> <b>Combination of HSC, retention and infiltration, harvest and use, and biotreatment BMPs provide less than full LID DCV capture.</b>  <i>Checked yes for Form 4.3-5 Item 7, Item 6 is zero, and sum of Items 2, 3, 4, and 5 is less than Item 1. If so, apply water quality credits and calculate volume for alternative compliance, <math>V_{alt} = (Item\ 1 - Item\ 2 - Item\ 3 - Item\ 4 - Item\ 5) * (100 - Form\ 2.4-1\ Item\ 2)\%</math></i></li> <li><input type="checkbox"/> <b>An approved Watershed Action Plan (WAP) demonstrates that water quality and hydrologic impacts of urbanization are more effective when managed in at an off-site facility.</b>  <i>Attach appropriate WAP section, including technical documentation, showing effectiveness comparisons for the project site and regional watershed</i></li> </ul>

### 4.3.6 Hydromodification Control BMP

Use Form 4.3-10 to compute the remaining runoff volume retention, after LID BMP are implemented, needed to address HCOC, and the increase in time of concentration and decrease in peak runoff necessary to meet targets for protection of waterbodies with a potential HCOC. Describe hydromodification control BMP that address HCOC, which may include off-site BMP and/or in-stream controls. Section 5.6 of the TGD for WQMP provides additional details on selection and evaluation of hydromodification control BMP.

<b>Form 4.3-10 Hydromodification Control BMPs</b>	
<p><sup>1</sup> <b>Volume reduction needed for HCOC performance criteria (ft<sup>3</sup>):</b> n/a <i>(Form 4.2-2 Item 4 * 0.95) – Form 4.2-2 Item 1</i></p>	<p><sup>2</sup> <b>On-site retention with site design hydrologic source control, infiltration, and harvest and use LID BMP (ft<sup>3</sup>):</b> n/a <i>Sum of Form 4.3-9 Items 2, 3, and 4. Evaluate option to increase implementation of on-site retention in Forms 4.3-2, 4.3-3, and 4.3-4 in excess of LID DCV toward achieving HCOC volume reduction</i></p>
<p><sup>3</sup> <b>Remaining volume for HCOC volume capture (ft<sup>3</sup>):</b> n/a <i>Item 1 – Item 2</i></p>	<p><sup>4</sup> <b>Volume capture provided by incorporating additional on-site or off-site retention BMPs (ft<sup>3</sup>):</b> n/a <i>Existing downstream BMP may be used to demonstrate additional volume capture (if so, attach to this WQMP a hydrologic analysis showing how the additional volume would be retained during a 2-yr storm event for the regional watershed)</i></p>
<p><sup>5</sup> <b>If Item 4 is less than Item 3, incorporate in-stream controls on downstream waterbody segment to prevent impacts due to hydromodification</b> <i>Attach in-stream control BMP selection and evaluation to this WQMP</i></p>	
<p><sup>6</sup> <b>Is Form 4.2-2 Item 11 less than or equal to 5%:</b> <input type="checkbox"/>Yes <input type="checkbox"/>No <i>If yes, HCOC performance criteria is achieved. If no, select one or more mitigation options below:</i></p> <ul style="list-style-type: none"> <li><input type="checkbox"/> <b>Demonstrate increase in time of concentration achieved by proposed LID site design, LID BMP, and additional on-site or off-site retention BMP.</b> <i>BMP upstream of a waterbody segment with a potential HCOC may be used to demonstrate increased time of concentration through hydrograph attenuation (if so, show that the hydraulic residence time provided in BMP for a 2-year storm event is equal or greater than the addition time of concentration requirement in Form 4.2-4 Item 15)</i></li> <li><input type="checkbox"/> <b>Increase time of concentration by preserving pre-developed flow path and/or increase travel time by reducing slope and increasing cross-sectional area and roughness for proposed on-site conveyance facilities.</b></li> <li><input type="checkbox"/> <b>Incorporate appropriate in-stream controls for downstream waterbody segment to prevent impacts due to hydromodification, in a plan approved and signed by a licensed engineer in the State of California.</b></li> </ul>	
<p><sup>7</sup> <b>Form 4.2-2 Item 12 less than or equal to 5%:</b> <input type="checkbox"/>Yes <input type="checkbox"/>No <i>If yes, HCOC performance criteria are achieved. If no, select one or more mitigation options below:</i></p> <ul style="list-style-type: none"> <li><input type="checkbox"/> <b>Demonstrate reduction in peak runoff achieved by proposed LID site design, LID BMPs, and additional on-site or off-site retention BMPs.</b> <i>BMPs upstream of a waterbody segment with a potential HCOC may be used to demonstrate additional peak runoff reduction through hydrograph attenuation (if so, attach to this WQMP, a hydrograph analysis showing how the peak runoff would be reduced during a 2-yr storm event)</i></li> <li><input type="checkbox"/> <b>Incorporate appropriate in-stream controls for downstream waterbody segment to prevent impacts due to hydromodification, in a plan approved and signed by a licensed engineer in the State of California.</b></li> </ul>	

## 4.4 Alternative Compliance Plan (if applicable)

Describe an alternative compliance plan (if applicable) for projects not fully able to infiltrate, harvest and use, or biotreat the DCV via on-site LID practices. A project proponent must develop an alternative compliance plan to address the remainder of the LID DCV. Depending on project type some projects may qualify for water quality credits that can be applied to reduce the DCV that must be treated prior to development of an alternative compliance plan (see Form 2.4-1, Water Quality Credits). Form 4.3-9 Item 8 includes instructions on how to apply water quality credits when computing the DCV that must be met through alternative compliance. Alternative compliance plans may include one or more of the following elements:

- On-site structural treatment control BMP - All treatment control BMP should be located as close to possible to the pollutant sources and should not be located within receiving waters;
- Off-site structural treatment control BMP - Pollutant removal should occur prior to discharge of runoff to receiving waters;
- Urban runoff fund or In-lieu program, if available

Depending upon the proposed alternative compliance plan, approval by the executive officer may or may not be required (see Section 6 of the TGD for WQMP).

## Section 5 Inspection and Maintenance Responsibility for Post Construction BMP

All BMP included as part of the project WQMP are required to be maintained through regular scheduled inspection and maintenance (refer to Section 8, Post Construction BMP Requirements, in the TGD for WQMP). Fully complete Form 5-1 summarizing all BMP included in the WQMP. Attach additional forms as needed. The WQMP shall also include a detailed Operation and Maintenance Plan for all BMP and may require a Maintenance Agreement (consult the jurisdiction's LIP). If a Maintenance Agreement is required, it must also be attached to the WQMP.

<b>Form 5-1 BMP Inspection and Maintenance</b>			
<b>BMP</b>	<b>Responsible Party(ies)</b>	<b>Inspection/Maintenance Activities Required</b>	<b>Minimum Frequency of Activities</b>
Hydrodynamic Separator	Owner	Visual inspection to quantify the accumulation of hydrocarbons, trash, and sediment in the system. Use vacuum truck to clean and remove pollutants from the system upon reaching 75% capacity. Clean area outside of the screen if pollutant build-up exists.	Visually inspect twice a year (spring and fall) or as frequently as needed. Vacuum frequency as determined by inspection.
Underground Infiltration Chambers	Owner	The isolator rows shall be inspected for debris and sediment accumulations and maintained by a qualified technician and he/she will properly dispose of all wastes and inspect for standing water. A manhole is installed in order to inspect and maintain the inlet row. All entry into the chamber system must be done per OSHA codes to ensure operator and inspector safety.	The isolator rows shall be inspected semi-annually (by October 1st and February 1st) and cleaned by water-flush and vacuum when solids accumulate to 3" depth. Maintenance to be conducted through service contract with the vendor or equally qualified contractor.
N1: Education of Property Owners, Tenants and Occupants on Stormwater BMPs	Owner	Property owner will familiarize him/herself with the educational materials in Attachment "E" and the contents of the WQMP.	Annually for all employees and within 2 months for new hires.
N2: Activity Restrictions	Owner	No outdoor work areas, processing, storage or wash area.	Ongoing
N3: Landscape Management BMPs	Owner	Irrigation must be consistent with the local agency's Water Conservation Ordinance. Fertilizer and pesticide usage will be consistent with local agency's Management Guidelines for Use of Fertilizers and Pesticides.	Ongoing
N4: BMP Maintenance	Owner	BMP maintenance, implementation schedules, and responsible parties are included with each specific BMP narrative.	As described in each BMP.
N7: Spill Contingency Plan	Owner	Owner/tenant will have a spill contingency plan based on individual site needs.	Ongoing
N10: Uniform Fire Code Implementation	Owner	Owner will comply with Article 80 of the Uniform Fire Code enforced by the fire protection agency.	Ongoing

<b>Form 5-1 BMP Inspection and Maintenance</b>			
<b>BMP</b>	<b>Responsible Party(ies)</b>	<b>Inspection/Maintenance Activities Required</b>	<b>Minimum Frequency of Activities</b>
N11: Litter/Debris Control Program	Owner	Contract with their landscape maintenance firm to provide this service during regularly schedule maintenance.	Weekly
N12: Employee Training	Owner	The owner will ensure that tenants are also familiar with onsite BMPs and necessary maintenance required of the tenants. Employees shall be trained to clean up spills and participate in ongoing maintenance. Owner will check with City and County at least once a year to obtain new or updated educational materials and provide these materials to tenants. The WQMP requires annual employee training and new hires within 2 months.	Annually for all employees and within 2 months for new hires.
N13: Housekeeping of Loading Docks	Owner	Keep all fluids indoors. Clean up spills immediately and keep spills from entering storm drain system. Area shall be inspected weekly for proper containment and practices with spills cleaned up immediately and disposed of properly.	Ongoing
N14: Catch Basin Inspection Program	Owner	Monthly inspection by property owner's designee. Sumps will be vacuumed when sediment or trash becomes 2-inches deep and disposed of properly.	Monthly inspection and maintain as necessary.
N15: Vacuum Sweeping of Private Streets and Parking Lots	Owner	All landscape maintenance contractors will be required to sweep up all landscape cuttings, mowings and fertilizer materials off paved areas weekly and dispose of properly. Parking areas and drive ways will be swept monthly by sweeping contractor.	Monthly
N17: Comply with all other applicable NPDES permits	Owner	Will comply with Construction General Permit and Industrial General Permit (may apply for No Exposure Certification/NEC).	Ongoing during construction.
S1: Provide storm drain system stenciling and signage (CASQA New Development BMP Handbook SD-13)	Owner	"No Dumping – Drains to River" stencils will be applied. Legibility of stencil will be maintained on a yearly basis.	Annually
S3: Design and construct trash and waste storage areas to reduce pollution introduction (CASQA New Development BMP Handbook SD-32)	Owner	Paved with an impervious surface, designed not to allow run-on from adjoining areas, designed to divert drainage from adjoining roofs and pavements diverted around the area, screened or walled to prevent off-site transport of trash.	Ongoing

<b>Form 5-1 BMP Inspection and Maintenance</b>			
<b>BMP</b>	<b>Responsible Party(ies)</b>	<b>Inspection/Maintenance Activities Required</b>	<b>Minimum Frequency of Activities</b>
S4: Use efficient irrigation systems & landscape design, water conservation, smart controllers, and source control (Statewide Model Landscape Ordinance; CASQA New Development BMP Handbook SD-12)	Owner	Irrigation systems shall include shutoff valves triggered by a pressure drop to control water loss in the event of broken sprinkler heads or lines. Timers will be used to avoid over watering and watering cycles and duration shall be adjusted seasonally by the landscape maintenance contractor. The landscaping areas will be grouped with plants that have similar water requirements. Native or drought tolerant species shall also be used where appropriate to reduce excess irrigation runoff and promote surface filtration.	Adjust watering cycles and duration seasonally / quarterly.
S5: Finish grade of landscaped areas at a minimum of 1-2 inches below top of curb, sidewalk, or pavement	Owner	Landscaped areas will be depressed in order to increase retention of stormwater/irrigation water and promote infiltration.	Ongoing

## Section 6 WQMP Attachments

### 6.1 Site Plan and Drainage Plan

Include a site plan and drainage plan sheet set containing the following minimum information:

- Project location
- Site boundary
- Land uses and land covers, as applicable
- Suitability/feasibility constraints
- Structural Source Control BMP locations
- Site Design Hydrologic Source Control BMP locations
- LID BMP details
- Drainage delineations and flow information
- Drainage connections

See Attachment C for WQMP Site Map.

### 6.2 Electronic Data Submittal

Minimum requirements include submittal of PDF exhibits in addition to hard copies. Format must not require specialized software to open. If the local jurisdiction requires specialized electronic document formats (consult the LIP), this section will describe the contents (e.g., layering, nomenclature, geo-referencing, etc.) of these documents so that they may be interpreted efficiently and accurately.

### 6.3 Post Construction

Attach all O&M Plans and Maintenance Agreements for BMP to the WQMP (Attachment D).

### 6.4 Other Supporting Documentation

- Existing Site Photos (Attachment A)
- BMP Design Calculations & Supporting Documentation (Attachment B)
- Maintenance Agreement (Attachment D)
- BMP Educational Materials (Attachment E)
- Infiltration Report (Attachment F)
- BMP O&M (Attachment G)

**Attachment A**  
**Existing Condition Site Photos**





**Attachment B**  
**BMP Design Calculations & Supporting**  
**Documentation**





Home Site Map Organization Search   NWS  All NOAA

- General Information
- Homepage
- Progress Reports
- FAQ
- Glossary

## NOAA ATLAS 14 POINT PRECIPITATION FREQUENCY ESTIMATES: CA

### Data description

Data type:  Units:  Time series type:

### Select location

#### 1) Manually:

a) By location (decimal degrees, use "-" for S and W): Latitude:  Longitude:

b) By station (list of CA stations):

c) By address

2) Use map (if ESRI interactive map is not loading, try adding the host: <https://js.arcgis.com/> to the firewall, or contact us at [hdsc.questions@noaa.gov](mailto:hdsc.questions@noaa.gov)):

a) Select location  
Move crosshair or double click

b) Click on station icon  
 Show stations on map

**Location information:**  
 Name: San Bernardino, California, USA\*  
 Latitude: 34.0822°  
 Longitude: -117.2735°  
 Elevation: 1025.57 ft \*\*

\* Source: ESRI Maps  
 \*\* Source: USGS

### POINT PRECIPITATION FREQUENCY (PF) ESTIMATES WITH 90% CONFIDENCE INTERVALS AND SUPPLEMENTARY INFORMATION NOAA Atlas 14, Volume 6, Version 2

PF tabular      PF graphical      Supplementary information      [Print page](#)

PDS-based precipitation frequency estimates with 90% confidence intervals (in inches) <sup>1</sup>										
Duration	Average recurrence interval (years)									
	1	2	5	10	25	50	100	200	500	1000
5-min	0.101 (0.084-0.123)	0.133 (0.111-0.162)	0.176 (0.146-0.214)	0.210 (0.173-0.259)	0.258 (0.205-0.328)	0.295 (0.229-0.383)	0.332 (0.252-0.443)	0.371 (0.273-0.509)	0.425 (0.300-0.608)	0.466 (0.318-0.691)
10-min	0.145 (0.121-0.176)	0.191 (0.159-0.232)	0.252 (0.209-0.307)	0.302 (0.248-0.371)	0.370 (0.294-0.470)	0.422 (0.328-0.549)	0.476 (0.361-0.635)	0.532 (0.392-0.730)	0.609 (0.430-0.871)	0.668 (0.455-0.991)
15-min	0.176 (0.146-0.213)	0.231 (0.192-0.281)	0.305 (0.253-0.371)	0.365 (0.300-0.448)	0.447 (0.355-0.569)	0.511 (0.397-0.664)	0.576 (0.437-0.768)	0.644 (0.474-0.883)	0.736 (0.519-1.05)	0.808 (0.551-1.20)
30-min	0.260 (0.217-0.316)	0.343 (0.285-0.417)	0.452 (0.375-0.551)	0.541 (0.445-0.665)	0.663 (0.527-0.843)	0.758 (0.589-0.985)	0.854 (0.648-1.14)	0.955 (0.703-1.31)	1.09 (0.771-1.56)	1.20 (0.817-1.78)
60-min	0.380 (0.316-0.461)	0.500 (0.416-0.608)	0.659 (0.546-0.803)	0.789 (0.648-0.969)	0.966 (0.768-1.23)	1.10 (0.858-1.43)	1.25 (0.944-1.66)	1.39 (1.02-1.91)	1.59 (1.12-2.28)	1.75 (1.19-2.59)
2-hr	0.545 (0.453-0.661)	0.704 (0.585-0.855)	0.913 (0.757-1.11)	1.08 (0.890-1.33)	1.32 (1.05-1.67)	1.49 (1.16-1.94)	1.68 (1.27-2.23)	1.86 (1.37-2.56)	2.12 (1.49-3.03)	2.31 (1.58-3.43)
3-hr	0.669 (0.557-0.811)	0.858 (0.713-1.04)	1.11 (0.917-1.35)	1.31 (1.08-1.61)	1.58 (1.26-2.01)	1.80 (1.40-2.33)	2.01 (1.52-2.68)	2.23 (1.64-3.06)	2.53 (1.79-3.62)	2.76 (1.88-4.09)
6-hr	0.926 (0.771-1.12)	1.18 (0.982-1.44)	1.52 (1.26-1.85)	1.79 (1.47-2.20)	2.16 (1.71-2.74)	2.44 (1.90-3.17)	2.73 (2.07-3.64)	3.03 (2.23-4.15)	3.42 (2.42-4.90)	3.73 (2.54-5.53)
12-hr	1.22	1.57	2.02	2.38	2.88	3.26	3.65	4.04	4.58	4.99

	(1.02-1.48)	(1.30-1.90)	(1.67-2.46)	(1.96-2.93)	(2.29-3.66)	(2.54-4.24)	(2.76-4.86)	(2.98-5.54)	(3.23-6.55)	(3.40-7.40)
24-hr	<b>1.62</b> (1.44-1.87)	<b>2.10</b> (1.86-2.43)	<b>2.74</b> (2.41-3.17)	<b>3.25</b> (2.84-3.79)	<b>3.95</b> (3.34-4.75)	<b>4.48</b> (3.72-5.51)	<b>5.02</b> (4.07-6.32)	<b>5.58</b> (4.40-7.22)	<b>6.33</b> (4.79-8.54)	<b>6.91</b> (5.06-9.64)
2-day	<b>1.97</b> (1.74-2.27)	<b>2.60</b> (2.30-3.00)	<b>3.43</b> (3.02-3.96)	<b>4.10</b> (3.59-4.78)	<b>5.03</b> (4.26-6.06)	<b>5.74</b> (4.76-7.06)	<b>6.47</b> (5.24-8.15)	<b>7.22</b> (5.69-9.35)	<b>8.24</b> (6.24-11.1)	<b>9.04</b> (6.61-12.6)
3-day	<b>2.11</b> (1.87-2.43)	<b>2.82</b> (2.49-3.25)	<b>3.77</b> (3.32-4.36)	<b>4.55</b> (3.98-5.30)	<b>5.62</b> (4.76-6.77)	<b>6.45</b> (5.35-7.93)	<b>7.31</b> (5.92-9.20)	<b>8.19</b> (6.46-10.6)	<b>9.41</b> (7.12-12.7)	<b>10.4</b> (7.59-14.5)
4-day	<b>2.25</b> (1.99-2.59)	<b>3.03</b> (2.68-3.50)	<b>4.08</b> (3.60-4.72)	<b>4.96</b> (4.34-5.78)	<b>6.16</b> (5.22-7.42)	<b>7.10</b> (5.89-8.73)	<b>8.07</b> (6.54-10.2)	<b>9.08</b> (7.16-11.8)	<b>10.5</b> (7.93-14.1)	<b>11.6</b> (8.47-16.1)
7-day	<b>2.58</b> (2.28-2.97)	<b>3.53</b> (3.12-4.08)	<b>4.82</b> (4.25-5.58)	<b>5.89</b> (5.15-6.87)	<b>7.38</b> (6.25-8.89)	<b>8.55</b> (7.09-10.5)	<b>9.76</b> (7.91-12.3)	<b>11.0</b> (8.69-14.3)	<b>12.8</b> (9.68-17.2)	<b>14.2</b> (10.4-19.8)
10-day	<b>2.79</b> (2.47-3.22)	<b>3.86</b> (3.42-4.46)	<b>5.31</b> (4.68-6.15)	<b>6.52</b> (5.71-7.61)	<b>8.21</b> (6.96-9.89)	<b>9.54</b> (7.92-11.7)	<b>10.9</b> (8.85-13.8)	<b>12.4</b> (9.76-16.0)	<b>14.4</b> (10.9-19.4)	<b>16.0</b> (11.7-22.3)
20-day	<b>3.42</b> (3.03-3.94)	<b>4.79</b> (4.24-5.53)	<b>6.66</b> (5.88-7.71)	<b>8.24</b> (7.21-9.61)	<b>10.5</b> (8.86-12.6)	<b>12.2</b> (10.1-15.0)	<b>14.1</b> (11.4-17.7)	<b>16.0</b> (12.6-20.7)	<b>18.7</b> (14.2-25.2)	<b>20.9</b> (15.3-29.1)
30-day	<b>4.03</b> (3.57-4.65)	<b>5.66</b> (5.00-6.53)	<b>7.88</b> (6.95-9.11)	<b>9.76</b> (8.54-11.4)	<b>12.4</b> (10.5-15.0)	<b>14.5</b> (12.1-17.9)	<b>16.7</b> (13.6-21.1)	<b>19.1</b> (15.1-24.7)	<b>22.4</b> (16.9-30.2)	<b>25.0</b> (18.3-34.9)
45-day	<b>4.85</b> (4.29-5.58)	<b>6.74</b> (5.96-7.78)	<b>9.34</b> (8.24-10.8)	<b>11.6</b> (10.1-13.5)	<b>14.7</b> (12.4-17.7)	<b>17.2</b> (14.3-21.2)	<b>19.9</b> (16.1-25.0)	<b>22.7</b> (17.9-29.3)	<b>26.6</b> (20.1-35.9)	<b>29.8</b> (21.8-41.5)
60-day	<b>5.69</b> (5.04-6.55)	<b>7.82</b> (6.91-9.02)	<b>10.8</b> (9.48-12.4)	<b>13.2</b> (11.6-15.5)	<b>16.8</b> (14.2-20.2)	<b>19.7</b> (16.3-24.2)	<b>22.7</b> (18.4-28.6)	<b>25.9</b> (20.4-33.5)	<b>30.4</b> (23.0-41.0)	<b>34.0</b> (24.9-47.4)

<sup>1</sup> Precipitation frequency (PF) estimates in this table are based on frequency analysis of partial duration series (PDS).  
 Numbers in parenthesis are PF estimates at lower and upper bounds of the 90% confidence interval. The probability that precipitation frequency estimates (for a given duration and average recurrence interval) will be greater than the upper bound (or less than the lower bound) is 5%. Estimates at upper bounds are not checked against probable maximum precipitation (PMP) estimates and may be higher than currently valid PMP values.  
 Please refer to NOAA Atlas 14 document for more information.

Estimates from the table in CSV format:

Main Link Categories:  
[Home](#) | [OWP](#)

US Department of Commerce  
 National Oceanic and Atmospheric Administration  
 National Weather Service  
 Office of Water Prediction (OWP)  
 1325 East West Highway  
 Silver Spring, MD 20910  
 Page Author: [HDSC webmaster](#)  
 Page last modified: April 21, 2017

Map Disclaimer  
 Disclaimer  
 Credits  
 Glossary

Privacy Policy  
 About Us  
 Career Opportunities

**Worksheet H: Factor of Safety and Design Infiltration Rate Worksheet**

Factor Category		Factor Description	Assigned Weight (w)	Factor Value (v)	Product (p) $p = w \times v$
A	Suitability Assessment	Soil assessment methods	0.25	1	0.25
		Predominant soil texture	0.25	1	0.25
		Site soil variability	0.25	1	0.25
		Depth to groundwater / impervious layer	0.25	1	0.25
		Suitability Assessment Safety Factor, $S_A = \Sigma p$			
B	Design	Tributary area size	0.25	3	0.75
		Level of pretreatment/ expected sediment loads	0.25	1.5	0.375
		Redundancy	0.25	3	0.75
		Compaction during construction	0.25	1	0.25
		Design Safety Factor, $S_B = \Sigma p$			
Combined Safety Factor, $S_{TOT} = S_A \times S_B$				2.125	
Measured Infiltration Rate, inch/hr, $K_M$ (corrected for test-specific bias)				2.80	
Design Infiltration Rate, in/hr, $K_{DESIGN} = K_M / S_{TOT}$				1.32	

**Supporting Data**

Briefly describe infiltration test and provide reference to test forms:

A site-specific infiltration test was conducted at the project site to support a measured infiltration rate of 2.80 in/hr. The design infiltration rate will be 1.32 in/hr after applying the appropriate safety factor. This design rate is suitable for infiltration facilities.

**Note:** The minimum combined adjustment factor shall not be less than 2.0 and the maximum combined adjustment factor shall not exceed 9.0.

## FLOW-BASED BMP DESIGN (pretreatment)

$$C_{BMP} = 0.858(\text{imp})^3 - 0.78(\text{imp})^2 + 0.774(\text{imp}) + 0.04$$

$$I_{BMP} = (0.500)(0.2787)(2) = 0.279 \text{ in/hr}$$

$$Q = C_{BMP} * 0.279 * \text{Area}$$

### DA 1 DMA A – CDS UNIT

Region		Valley	
Drainage Area (acres)		11.50	acres
Drainage Area (sq-ft)		500,940	sq-ft
Impervious Coeff	i =	0.95	< 1.0
Runoff Coeff	C =	0.81	
<a href="#">1-hr 2-yr from NOAA</a>		0.500	
Intensity Coeff		0.2787	
Intensity BMP (in/hr)		0.279	
Flow (cfs)	Q =	2.59	

Contech CDS Unit CDS3030-6

Q-required = 2.59 cfs

Q-provided = 3.00 cfs

# VOLUME-BASED BMP DESIGN

$$C_{BMP} = 0.858(imp)^3 - 0.78(imp)^2 + 0.774(imp) + 0.04$$

$$P6 = (0.500)(1.4807) = 0.740 \text{ inches}$$

$$P0 = (1.963)(C_{BMP})(0.740)$$

$$DCV = (P0 * Area) / 12$$

## DA 1 DMA A – UNDERGROUND INFILTRATION CHAMBERS

Region	Valley	
Drainage Area (acres)	11.50	acres
Drainage Area (sq-ft)	500,940	sq-ft
Impervious Coeff	i = 0.95	< 1.0
Runoff Coeff	C = 0.807	
<a href="#">1-hr 2-yr from NOAA</a>	0.500	
P6 Coeff	1.4807	
Mean 6-hr (P6)	0.740	
Drawdown Rate (a)	1.963	
DCV	48,958	cu-ft
DCV	1.124	acre-ft

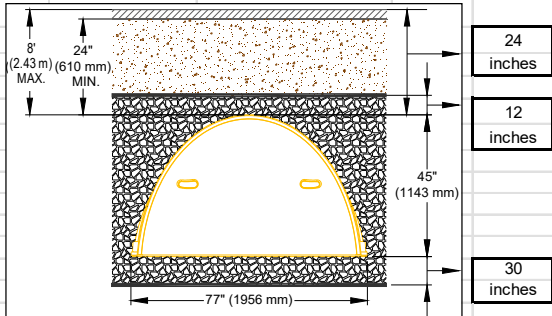
			<b>Project Information:</b>		
			Project Name:	TEI 3575	
			Location:		
			Date:	3/25/2022	
			Engineer:	Thienes Engineering, Inc	
			StormTech RPM:		
<b>MC-3500 Site Calculator</b>					
<b>System Requirements</b>			<b>System Sizing</b>		
Units		Imperial	Number of Chambers Required	224	each
Required Storage Volume	48958	CF	Number of End Caps Required	14	each
Stone Porosity (Industry Standard = 40%)	40	%	Bed Size (including perimeter stone)	12,038	square feet
Stone Above Chambers (12 inch min.)	12	inches	Stone Required (including perimeter stone)	3241	tons
Stone Foundation Depth (9 inch min.)	30	inches	Volume of Excavation	3678	cubic yards
Average Cover over Chambers (24 inch min.)	24	inches	Non-woven Filter Fabric Required (20% Safety Factor)	3762	square yards
Bed size controlled by WIDTH or LENGTH?	WIDTH		Length of Isolator Row	234.1	feet
Limiting WIDTH or LENGTH dimension	55	feet	Non-woven Isolator Row Fabric (20% Safety Factor)	406	square yards
Storage Volume per Chamber	214.9	CF	Woven Isolator Row Fabric (20% Safety Factor)	515	square yards
Storage Volume per End Cap	58.9	CF	Installed Storage Volume	48,962	cubic feet
<b>Controlled by Width (Rows)</b>					
Maximum Width =	55	feet			
7 rows of	32	chambers			
Maximum Length =	234.11	feet			
Maximum Width =	51.42	feet			

Design infiltration rate = 1.32 in/hr

$$d_{max} = 63.36 \text{ inches} = \text{Design infiltration rate} \times 48 \text{ hours} = 1.32 \text{ in/hr} \times 48 \text{ hrs}$$

$$d_{BMP} = 61.80 \text{ inches} = [(30 \text{ inches} + 12 \text{ inches}) \times 0.40] + 45 \text{ inches}$$

$$d_{max} > d_{BMP}$$

**Attachment C**  
**WQMP Site Map**



**Figure F-1**

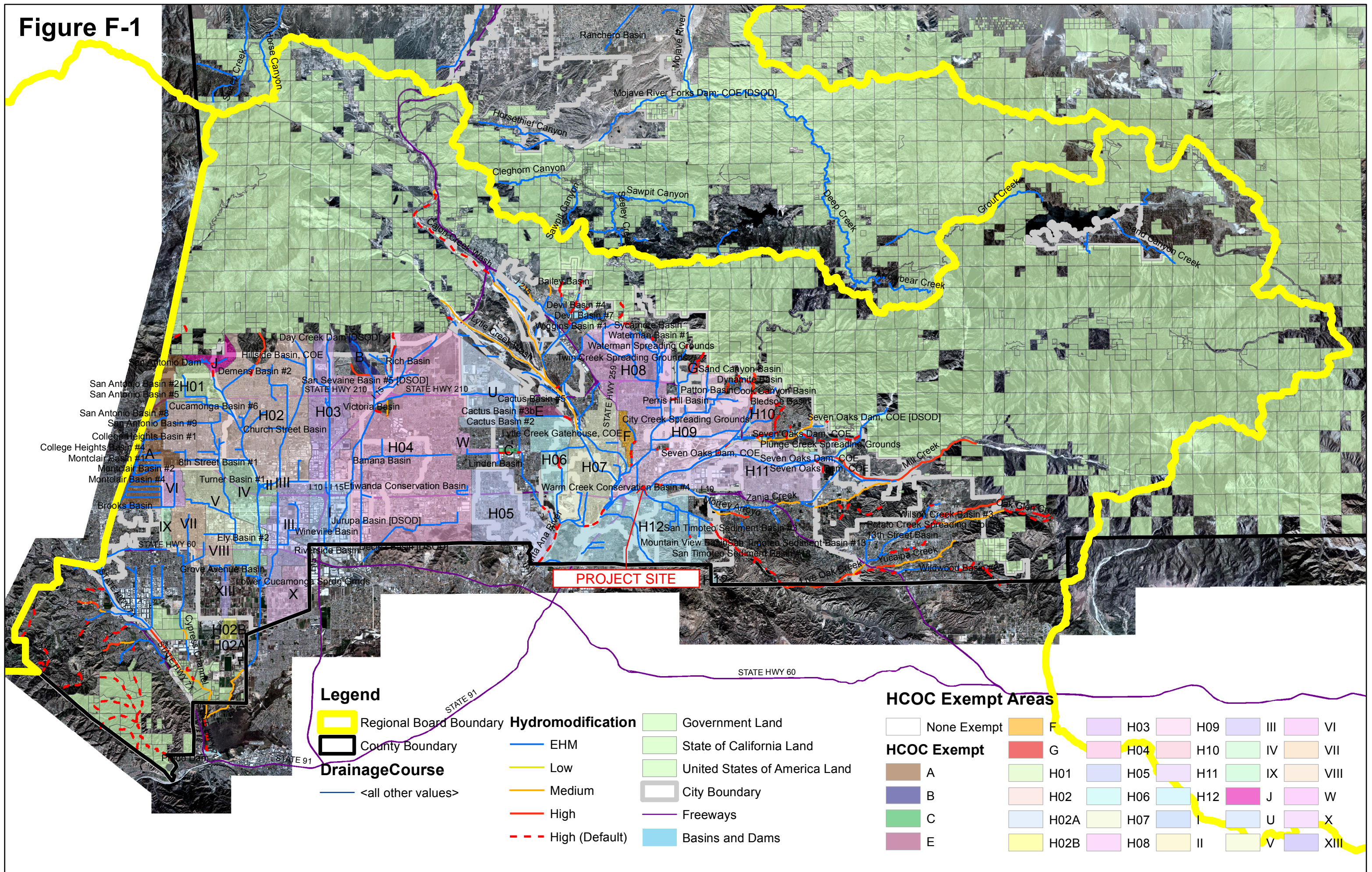





Last Update: 3/9/22  
O:\3900-3999\3957\3957VicMap.dwg

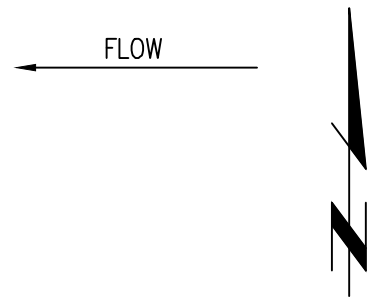

**TEI** Thienes Engineering, Inc.  
 CIVIL ENGINEERING • LAND SURVEYING  
 14349 FIRESTONE BOULEVARD  
 LA MIRADA, CALIFORNIA 90638  
 PH.(714)521-4811 FAX(714)521-4173

**"RECEIVING WATERS MAP"**  
 FOR  
**HILLWOOD GATEWAY SOUTH BUILDING 8**  
**SAN BERNARDINO, CA**



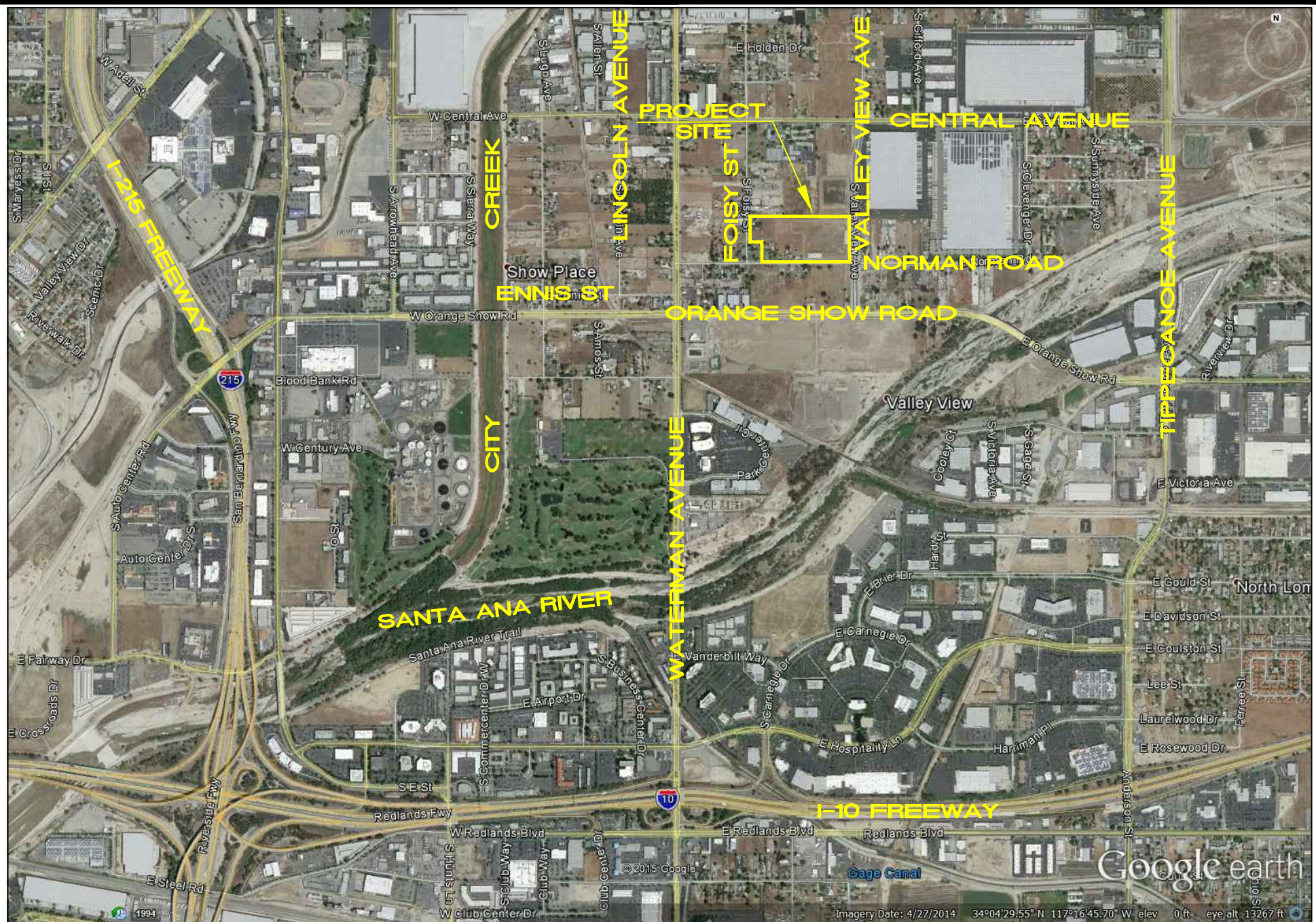

Last Update: 1/12/22  
 O: \\3500-3599\35775\3575VicMap.dwg

**TEI** Thienes Engineering, Inc.  
 CIVIL ENGINEERING • LAND SURVEYING  
 14349 FIRESTONE BOULEVARD  
 LA MIRADA, CALIFORNIA 90638  
 PH. (714) 521-4811 FAX (714) 521-4173

VICINITY MAP  
 FOR  
**HILLWOOD GATEWAY SOUTH BUILDING 8**  
**SAN BERNARDINO, CA**





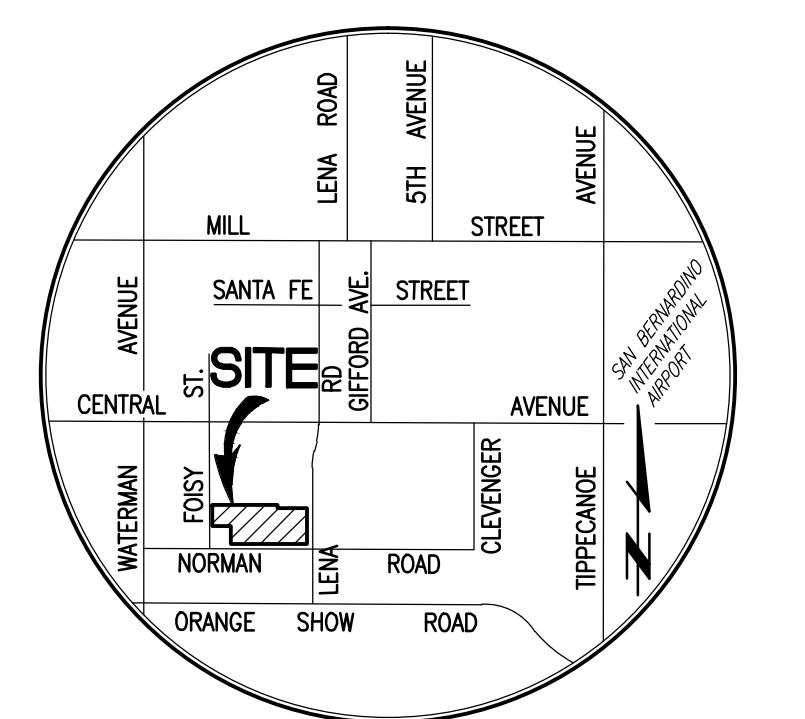
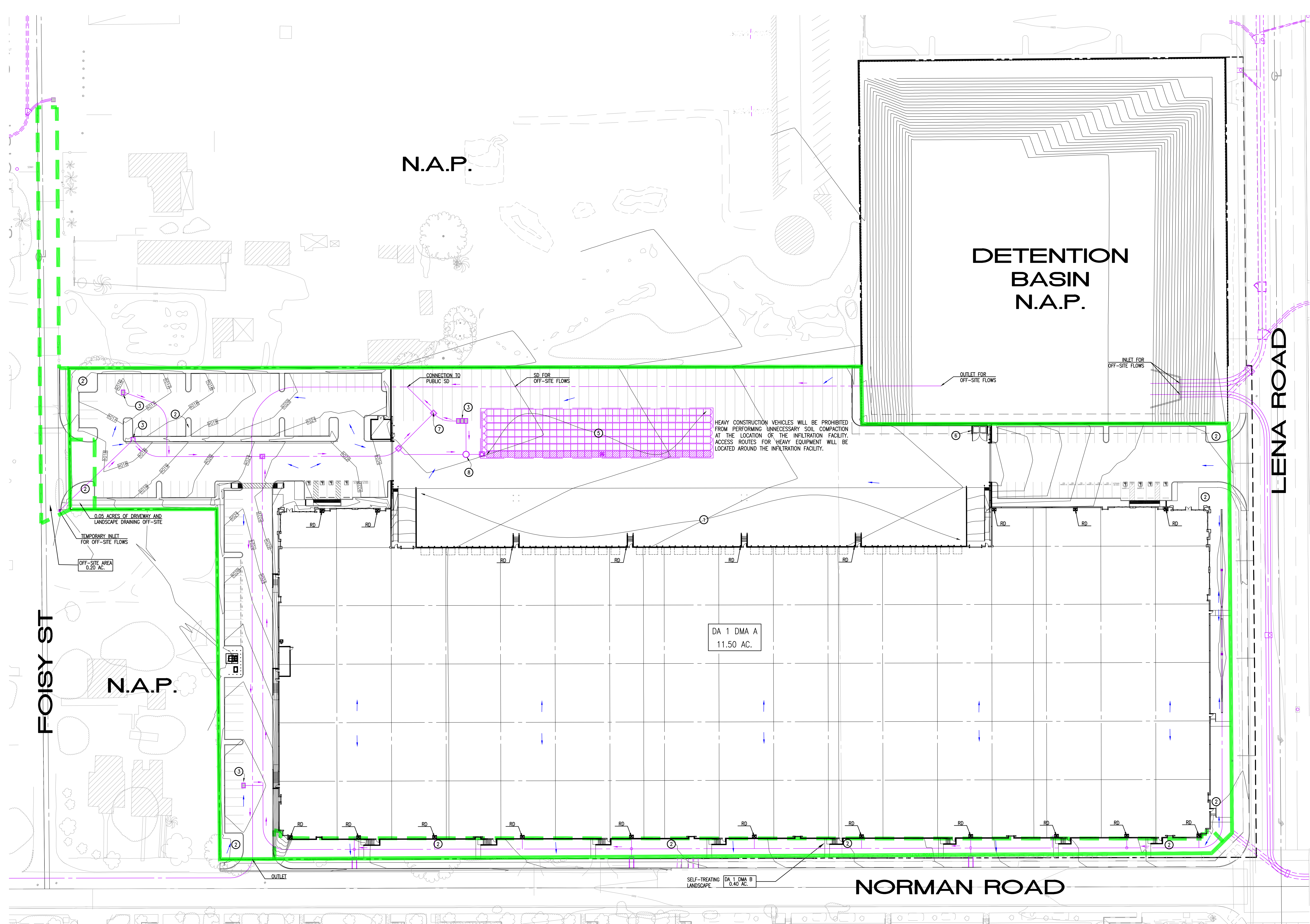

VICINITY MAP  
N.T.S.

**LEGEND**

- ① N13: HOUSEKEEPING OF LOADING DOCKS
- ② N3 & S4: LANDSCAPE MANAGEMENT BMPs (EFFICIENT IRRIGATION)
- ③ S1: CATCH BASIN STENCIL "NO DUMPING-DRAINS TO RIVER"
- ④ N14: CATCH BASIN INSPECTION
- ⑤ NOT USED
- ⑥ STORMTECH MC-3500 CHAMBERS
- ⑦ S3: TRASH STORAGE AREA
- ⑧ HYDRA CONNECTOR PIPE SCREEN (CPS)
- ⑨ HYDRODYNAMIC SEPARATOR
- ⑩ N15: VACUUM SWEEPING PARKING AREAS
- ⑪ N1: EDUCATION OF STORMWATER BMPs
- ⑫ N12: EMPLOYEE TRAINING

**NOTES:**

- RD ROOF DRAIN
- BOUNDARY
- BOUNDARY AREAS
- DRAINAGE AREAS
- SURFACE FLOW DIRECTION
- SD FLOW DIRECTION



SAMPLE CATCH BASIN STENCIL

DA 1 DMA A  
11.50 AC.

SELF-TREATING  
LANDSCAPE  
DA 1 DMA B  
0.40 AC.

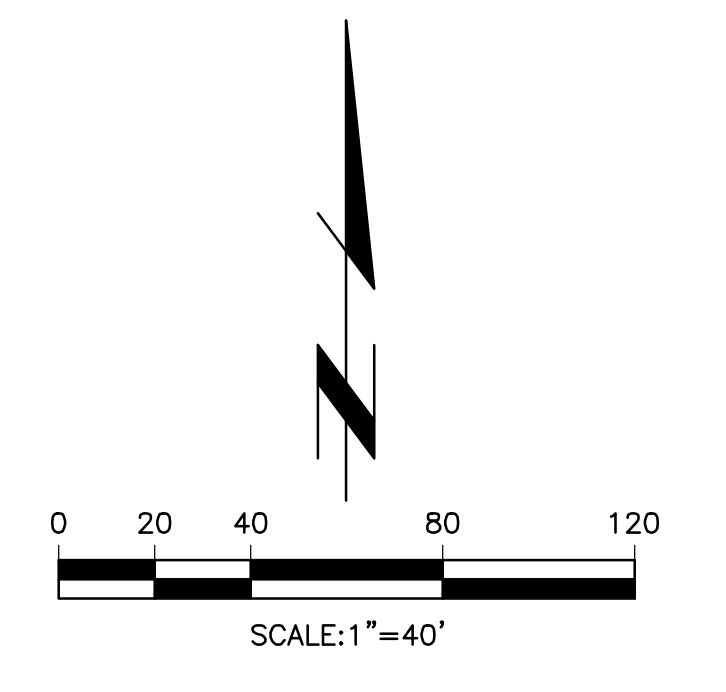

Last Update: 3/24/22  
01\_3500-3599\_3575\_3575BMPSTDMAP.dwg

**CITY OF SAN BERNARDINO**  
PUBLIC WORKS DEPARTMENT  
**WOMP SITE MAP**  
HILLWOOD GATEWAY SOUTH  
BUILDING 8  
N/W CORNER OF NORMAN RD.  
AND LENA RD.,  
SAN BERNARDINO, CA

**PREPARED FOR:**  
HILLWOOD INVESTMENTS  
901 VIA PIEMONTE, SUITE 175  
ONTARIO, CA 91764  
PHONE: (909) 382-0033  
FAX: (909) 382-0073

**PREPARED BY:**  
**Tai** Thienes Engineering, Inc.  
CIVIL ENGINEERING • LAND SURVEYING  
14340 FORESTONE BOULEVARD  
LA MIRADA, CALIFORNIA 90638  
PH: (714) 951-4111 FAX: (714) 951-4123

Designed by _____	Approved by _____
Checked by _____	Date _____
Designed by _____	Public Works Director _____ R.C.E. XXXXX
Checked by _____	Date _____
Date _____	Sheet <b>1</b> of <b>2</b> Sheets

3575/1 OF 2 SHEET



**HYDRA CONNECTOR PIPE SCREEN (CPS)  
U 5.7**

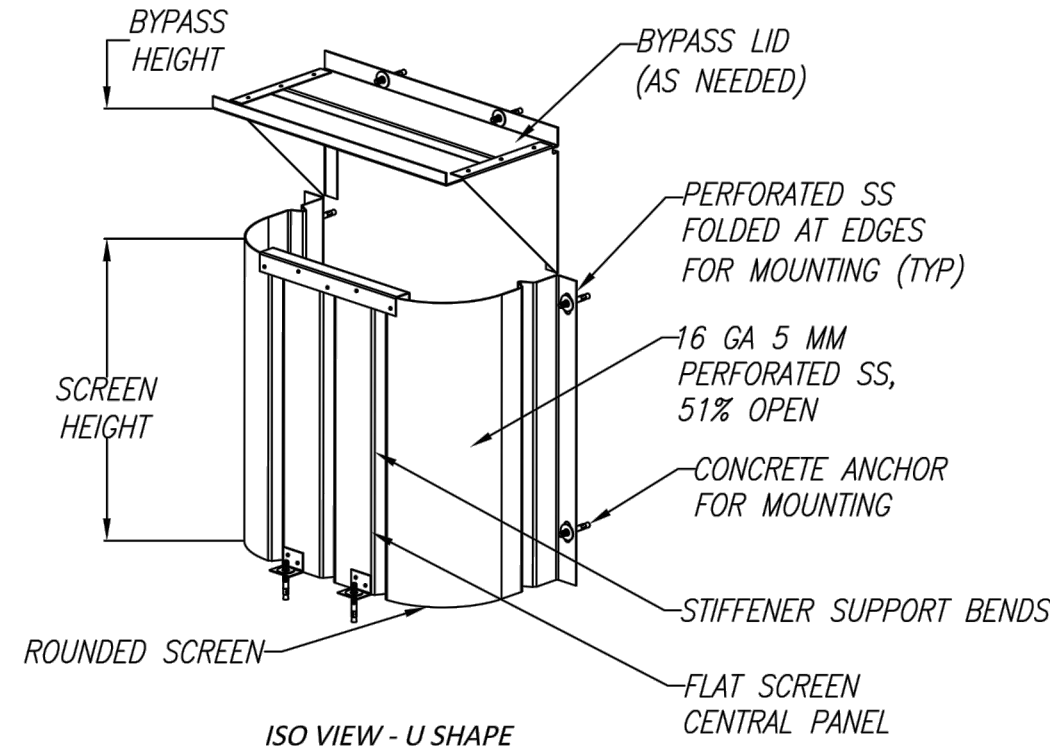

**CPS U WITH 5.7 FT SCREEN LENGTH**

CPS HEIGHT (IN)	SCREEN FLOW (CFS)
12	8.09
18	14.86
24	22.89
30	31.97
36	42.07

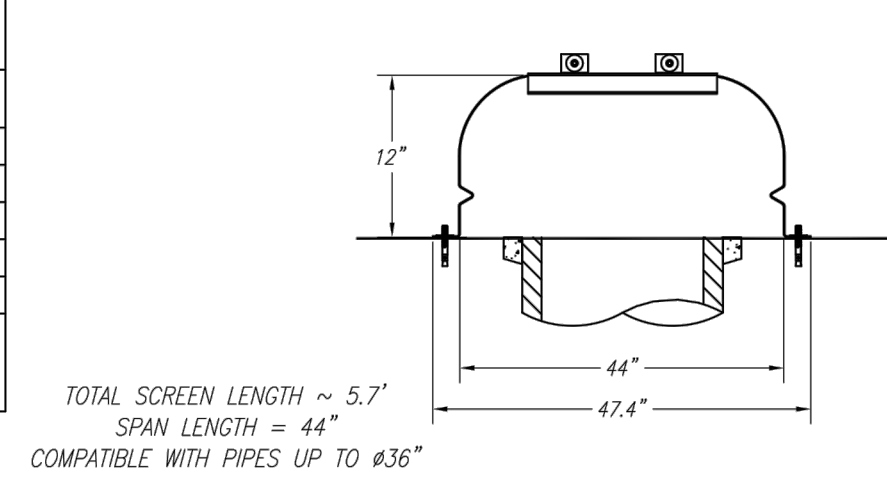

- GENERAL NOTES**
- CONTRACTOR TO PROVIDE ALL LABOR, EQUIPMENT, MATERIALS, AND INCIDENTALS REQUIRED TO INSTALL THE CPS UNIT AND APPEARANCES IN ACCORDANCE WITH THIS DRAWING AND THE MANUFACTURER'S SPECIFICATIONS, UNLESS OTHERWISE STATED IN MANUFACTURER'S CONTRACT.
  - POSITION THE CPS SO IT IS EVENLY SPACED AROUND THE CONNECTOR PIPE, ENSURING A MIN. OF 4" SPACING AROUND ANY CORNERS. SCREEN BOTTOM SHALL BE FLUSH WITH THE CATCH BOWL FLOOR, OR WITH GAPS NO GREATER THAN 5 MM.
  - IF A BYPASS LID IS REQUIRED, VERIFY THE BYPASS HEIGHT NEEDED AND MARK THAT LOCATION ON THE WALL DIRECTLY ABOVE THE BASE UPRIGHTS. LIFT THE LID IN PLACE AND MARK THE HOLE LOCATIONS FOR THE LID MOUNTING BRACKETS. SECURE THE LID WITH STAINLESS STEEL NUTS.

REVISIONS	DATE	REVISIONS	DATE

**StormTech ADS**

**STORMTECH MC-3500 CHAMBER**

Designed to meet the most stringent industry performance standards for superior structural integrity while providing designers with a cost-effective method to save valuable land and protect water resources. The StormTech system is designed primarily to be used under parking lots, thus maximizing land usage for private (commercial) and public applications. StormTech chambers can also be used in conjunction with Green Infrastructure, thus enhancing the performance and extending the service life of these practices.

Nominal Chamber Specifications	Nominal End Cap Specifications
<b>Size (L x W x H)</b> 90" x 77" x 45" 2,286 mm x 1,956 mm x 1,143 mm	<b>Size (L x W x H)</b> 26.5" x 71" x 45.1" 673 mm x 1,803 mm x 1,145 mm
<b>Chamber Storage</b> 108.9 ft <sup>3</sup> (3.11 m <sup>3</sup> )	<b>End Cap Storage</b> 14.9 ft <sup>3</sup> (0.42 m <sup>3</sup> )
<b>Min. Installed Storage*</b> 175.0 ft <sup>3</sup> (4.96 m <sup>3</sup> )	<b>Min. Installed Storage*</b> 45.1ft <sup>3</sup> (1.28 m <sup>3</sup> )
<b>Weight</b> 134 lbs (60.8 kg)	<b>Weight</b> 49 lbs (22.2 kg)
<b>Shipping</b> 15 chambers/pallet 7 end caps/pallet 7 pallets/truck	

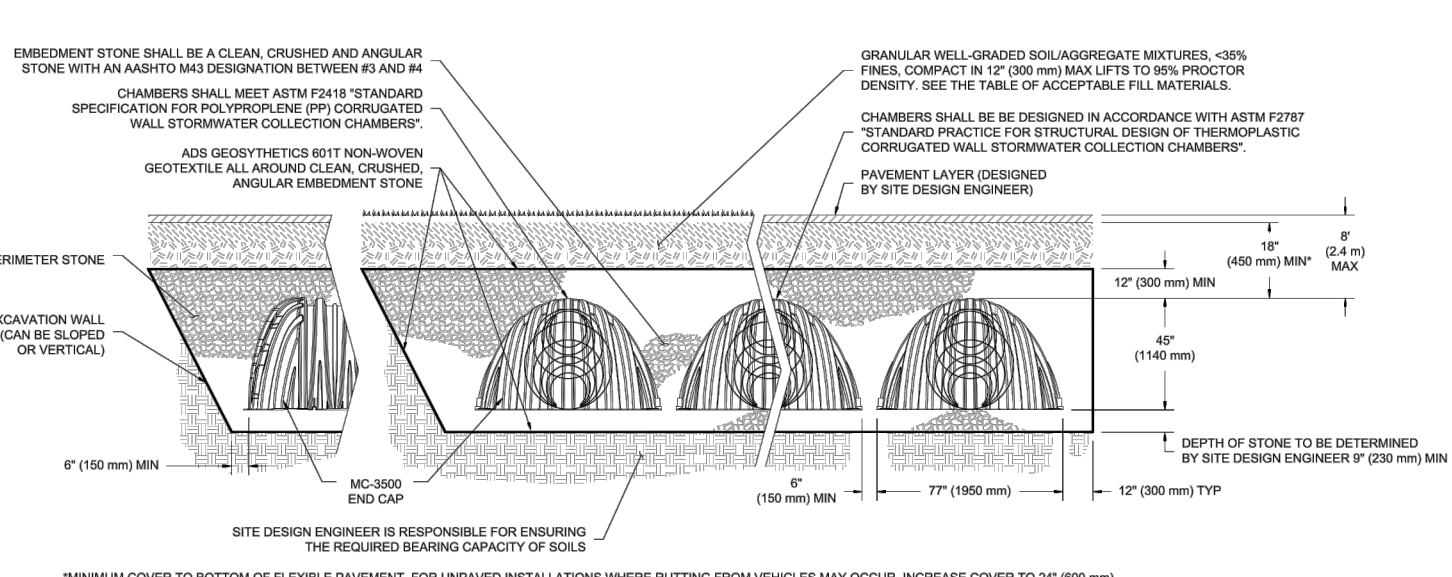

\*Assumes a minimum of 12" (300 mm) of stone above, 9" (230 mm) of stone below chambers, 6" (150 mm) of stone between chambers/end caps and 40% stone porosity.

**StormTech ADS**

**MC-3500 CHAMBER SPECIFICATION**

**STORAGE VOLUME PER CHAMBER FT<sup>3</sup> (M<sup>3</sup>)**

Base Chamber Storage (ft <sup>3</sup> )	Chamber and Stone Foundation Depth (ft)	12" (300 mm)	15" (375 mm)	18" (450 mm)
MC-3500 Chamber	108.9 (3.11)	175.0 (4.96)	191.0 (5.39)	204.0 (5.79)
MC-3500 End Cap	14.9 (0.42)	45.1 (1.28)	48.3 (1.37)	49.8 (1.41)

Note: Assumes 6" (150 mm) row spacing, 40% stone porosity, 12" (300 mm) stone above and includes the bare chamber/end cap volume.

**AMOUNT OF STONE PER CHAMBER**

ENGLISH TONS (yds <sup>3</sup> )	Stone Foundation Depth	9"	12"	15"	18"
MC-3500 Chamber	8.5 (0.6)	31.6 (0.9)	37.8 (0.9)	40.4 (0.9)	43.0 (0.9)
MC-3500 End Cap	3.0 (0.2)	4.1 (0.2)	4.3 (0.2)	4.5 (0.2)	4.5 (0.2)

**VOLUME EXCAVATION PER CHAMBER YD<sup>3</sup> (M<sup>3</sup>)**

Stone Foundation Depth	9"	12"	15"	18"
MC-3500 Chamber	11.9 (0.9)	12.4 (0.9)	12.8 (0.9)	13.3 (0.9)
MC-3500 End Cap	4.0 (0.3)	4.1 (0.3)	4.3 (0.3)	4.4 (0.3)



\*Assumes 6" (150 mm) of separation between chamber rows and 24" (600 mm) of cover. The volume of excavation will vary an depth of cover increases.



For more information on the StormTech MC-3500 Chamber and other ADS products, please contact our Customer Service Representatives at 1-800-821-6710

Advanced Drainage Systems, Inc.  
4044 Truman Blvd., Hilliard, OH 43026  
1-800-821-6710 www.ads-pipe.com

**CDS3030-6-C DESIGN NOTES**

CDS3030-6-C RATED TREATMENT CAPACITY IS 3.0 CFS (85 G/LM) OR PER LOCAL REGULATIONS. MAXIMUM HYDRAULIC INTERNAL BYPASS CAPACITY IS 20.0 CFS (566 L/M). IF THE SITE CONDITIONS EXCEED 20.0 CFS (566 L/M) AN UPSTREAM BYPASS STRUCTURE IS REQUIRED.

THE STANDARD CDS3030-6-C CONFIGURATION IS SHOWN. ALTERNATE CONFIGURATIONS ARE AVAILABLE AND ARE LISTED BELOW. SOME CONFIGURATIONS MAY BE COMBINED TO SUIT SITE REQUIREMENTS.

**CONFIGURATION DESCRIPTION**

GRATED INLET ONLY (NO INLET PIPE)	
GRATED INLET WITH INLET PIPE OR PIPES	
CURB INLET ONLY (NO INLET PIPE)	
CURB INLET WITH INLET PIPE OR PIPES	
SEPARATE OIL BAFFLE (SINGLE INLET PIPE REQUIRED FOR THIS CONFIGURATION)	
SEDIMENT WEIR FOR NDEP / NAGCAT CONFORMING UNITS	

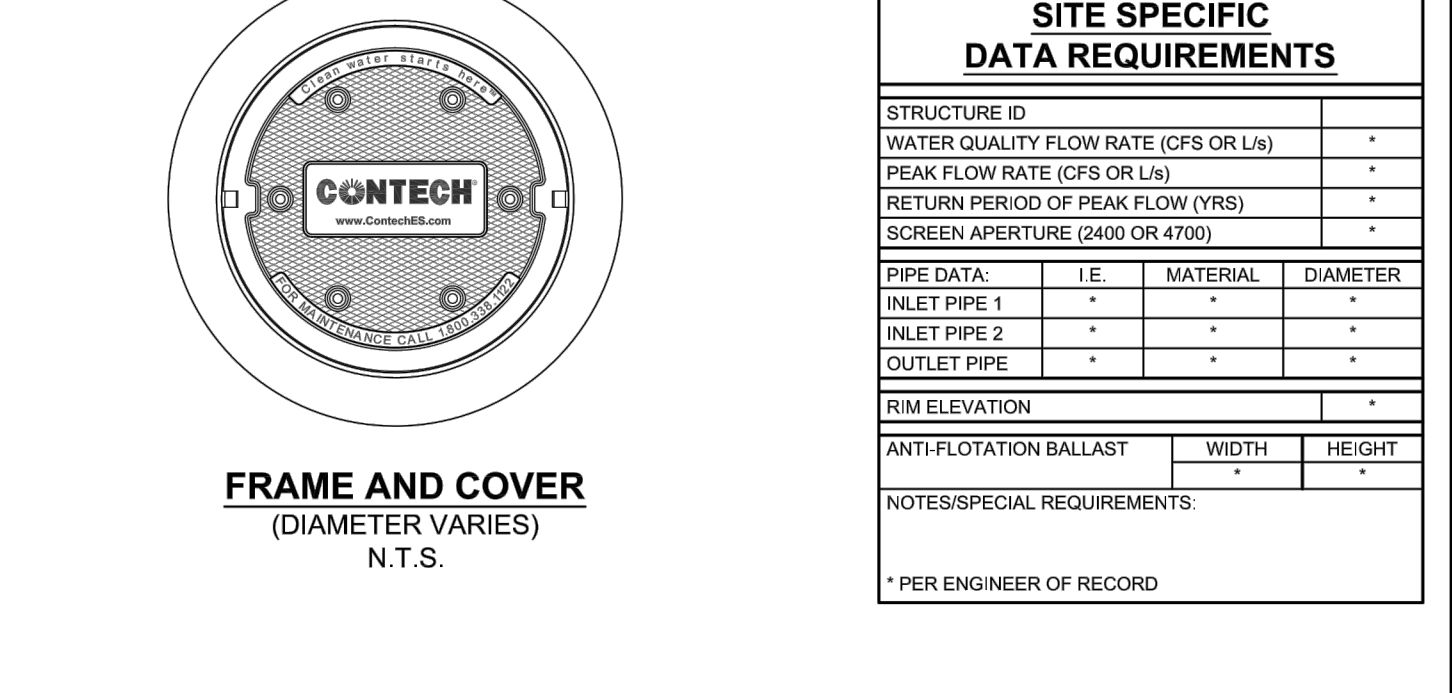
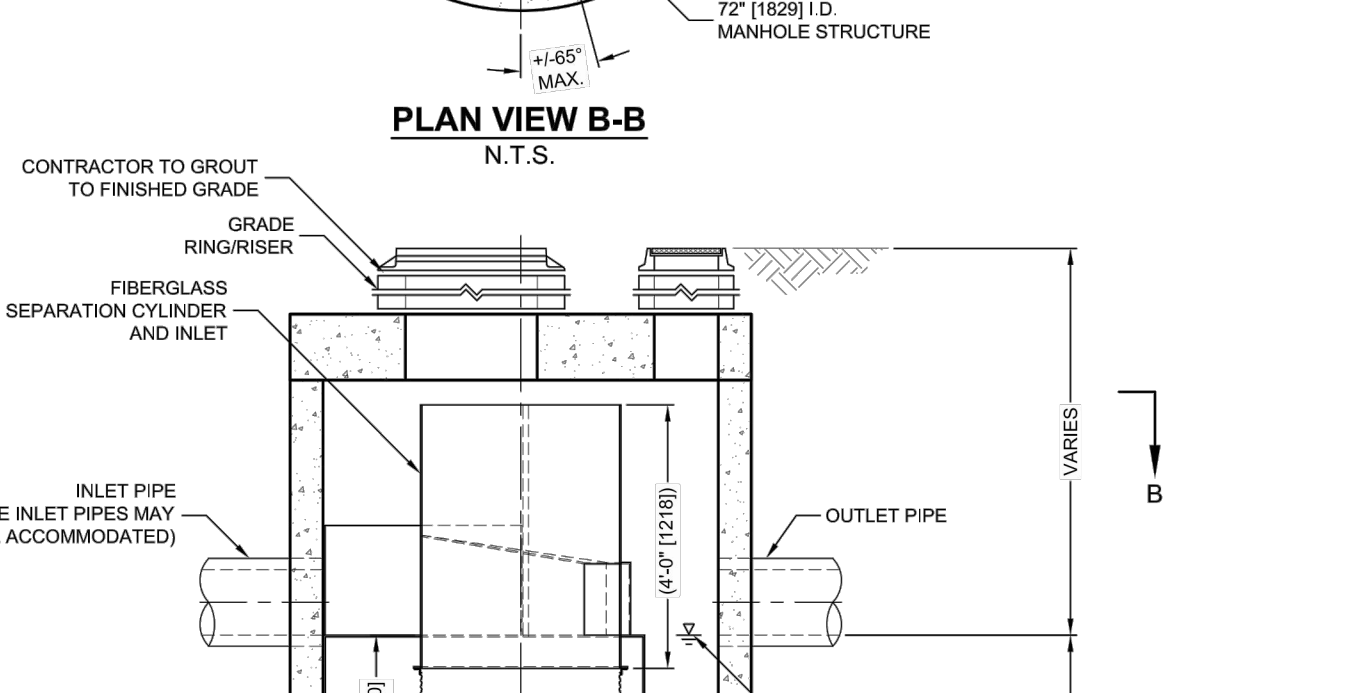

- SITE SPECIFIC DATA REQUIREMENTS**
- | STRUCTURE ID | WATER QUALITY FLOW RATE (GFS OR L/S) | PEAK FLOW RATE (GFS OR L/S) | RETURN PERIOD OF PEAK FLOW (YRS) | SCREEN APERTURE (2400 OR 4700) |
|--------------|--------------------------------------|-----------------------------|----------------------------------|--------------------------------|
|              |                                      |                             |                                  |                                |
- | PIPE DATA    | I.E. | MATERIAL | DIAMETER |
|--------------|------|----------|----------|
| INLET PIPE 1 |      |          |          |
| INLET PIPE 2 |      |          |          |
| OUTLET PIPE  |      |          |          |
- ANTI-FLOTATION BALLAST: WIDTH HEIGHT
- NOTES/SPECIAL REQUIREMENTS: \*PER ENGINEER OF RECORD

**GENERAL NOTES**

- CONTECH TO PROVIDE ALL MATERIALS UNLESS NOTED OTHERWISE.
- DIMENSIONS MARKED WITH ( ) ARE REFERENCE DIMENSIONS. ACTUAL DIMENSIONS MAY VARY.
- FOR FABRICATION DRAWINGS WITH DETAILED STRUCTURE DIMENSIONS AND WEIGHTS, PLEASE CONTACT YOUR CONTECH ENGINEERED SOLUTIONS LLC REPRESENTATIVE: www.contech.com
- CDS WATER QUALITY STRUCTURE SHALL BE IN ACCORDANCE WITH ALL DESIGN DATA AND INFORMATION CONTAINED IN THIS DRAWING.
- STRUCTURE SHALL MEET ASHTO H2010 AND CASTINGS SHALL MEET H2010 M 3000 LOAD RATING, ASSUMING GROUNDWATER ELEVATION AT, OR BELOW, THE OUTLET PIPE INVERT ELEVATION. ENGINEERS OF RECORD TO CONFIRM ACTUAL GROUNDWATER ELEVATION.
- PVC HYDRAULIC SHEAR PLATE IS PLACED ON SHELF AT BOTTOM OF SCREEN CYLINDER. REMOVE AND REPLACE AS NECESSARY DURING MAINTENANCE CLEANING.

**INSTALLATION NOTES**

- ANY SUB-BASE, BACKFILL DEPTH, AND/OR ANTI-FLOTATION PROVISIONS ARE SITE-SPECIFIC DESIGN CONSIDERATIONS AND SHALL BE SPECIFIED BY ENGINEER OF RECORD.
- CONTRACTOR TO PROVIDE EQUIPMENT WITH SUFFICIENT LIFTING AND REACH CAPACITY TO LIFT AND SET THE CDS MANHOLE STRUCTURE (LIFTING CLUTCHES PROVIDED).
- CONTRACTOR TO ADD JOINT SEALANT BETWEEN ALL STRUCTURE SECTIONS, AND ASSEMBLE STRUCTURE.
- CONTRACTOR TO PROVIDE, INSTALL, AND GROUT PIPES. MATCH PIPE INVERTS WITH ELEVATIONS SHOWN.
- CONTRACTOR TO TAKE APPROPRIATE MEASURES TO ASSURE UNIT IS WATER TIGHT, HOLDING WATER TO FLOWLINE INVERT MINIMUM. IT IS SUGGESTED THAT ALL JOINTS BELOW PIPE INVERTS ARE GROUTED.

**CONTECH ENGINEERED SOLUTIONS LLC**  
www.contech.com  
9025 Centre Pointe Dr., Suite 400, West Chester, OH 45386  
900-238-1122 913-846-7000 913-846-7000 FAX

**CDS3030-6-C INLINE CDS STANDARD DETAIL**

**Form 5-1 BMP Inspection and Maintenance**

BMP	Responsible Party(ies)	Inspection/Maintenance Activities Required	Minimum Frequency of Activities
Hydrodynamic Separator	Owner	Visual inspection to quantify the accumulation of hydrocarbons, trash, and sediment in the system. Use vacuum truck to clean and remove pollutants from the system upon reaching 75% capacity. Clean area outside of the screen if pollutant build up exists.	Visually inspect twice a year (spring and fall) or as frequently as needed. Vacuum frequency as determined by inspection.
Underground Infiltration Chambers	Owner	The isolator rows shall be inspected for debris and sediment accumulations and maintained by a qualified technician and he/she will properly dispose of all wastes and inspect for standing water. A manhole is installed in order to inspect and maintain in the inlet row. All entry into the chamber system must be done per OSHA codes to ensure operator and inspector safety.	The isolator rows shall be inspected semi-annually (by October 1st and February 1st) and cleaned by water-flush and vacuum when solids accumulate to 3" depth. Maintenance to be conducted through service contract with the vendor or equally qualified contractor.
N1: Education of Property Owners, Tenants and Occupants on Stormwater BMPs	Owner	Property owner will familiarize him/herself with the educational materials in attachment "E" and the contents of the WOMP.	Annually for all employees and within 2 months for new hires.
N2: Activity Restrictions	Owner	No outdoor work areas, processing, storage or wash areas.	Ongoing
N3: Landscape Management BMPs	Owner	Irrigation must be consistent with the local agency's Water Conservation Ordinance. Fertilizer and pesticide usage will be consistent with local agency's Management Guidelines for Use of Fertilizers and Pesticides.	Ongoing
N4: BMP Maintenance	Owner	BMP maintenance, implementation schedules, and responsible parties are included with each specific BMP narrative.	As described in each BMP.
N7: Spill Contingency Plan	Owner	Owner/tenant will have a spill contingency plan based on individual site needs.	Ongoing
N10: Uniform Fire Code Implementation	Owner	Owner will comply with Article 80 of the Uniform Fire Code enforced by the fire protection agency.	Ongoing
N11: Litter/Debris Control Program	Owner	Contractor with their landscape maintenance firm to provide this service during regularly schedule maintenance.	Weekly
N12: Employee Training	Owner	The owner will ensure that tenants are also familiar with onsite BMPs and necessary maintenance required of the tenants. Employees shall be trained to clean up spills and participate in ongoing maintenance. Owner will check with City and County at least once a year to obtain new or updated educational materials and provide these materials to tenants. The WOMP requires annual employee training and new hires within 2 months.	Annually for all employees and within 2 months for new hires.

**Form 5-1 BMP Inspection and Maintenance**

BMP	Responsible Party(ies)	Inspection/Maintenance Activities Required	Minimum Frequency of Activities
N13: Housekeeping of Loading Docks	Owner	Keep all fluids indoors. Clean up spills immediately and keep spills from entering storm drain system. Area shall be inspected weekly for proper containment and practices with spills cleaned up immediately and disposed of properly.	Ongoing
N14: Catch Basin Inspection Program	Owner	Monthly inspection by property owner's designee. Sumps will be vacuumed when sediment or trash becomes 2-inches deep and disposed of properly.	Monthly inspection and maintain as necessary.
N15: Vacuum Sweeping of Private Streets and Parking Lots	Owner	All landscape maintenance contractors will be required to sweep up all landscape cuttings, mowings and fertilizer materials off paved areas weekly and dispose of properly. Parking areas and drive ways will be swept monthly by sweeping contractor.	Monthly
N17: Comply with all other applicable NPDES permits	Owner	Will comply with Construction General Permit and Industrial General Permit (may apply for No Exposure Certification/NEC).	Ongoing during construction.
S1: Provide storm drain system stenciling and signage (CASQA New Development BMP Handbook SD-33)	Owner	"No Dumping - Drains to River" stencils will be applied. Legibility of stencil will be maintained on a yearly basis.	Annually
S3: Design and construct trash and waste storage areas to reduce pollution introduction (CASQA New Development BMP Handbook SD-32)	Owner	Paved with an impervious surface, designed not to allow run-on from adjoining areas, designed to divert drainage from adjoining roofs and pavements diverted around the area, screened or walled to prevent off-site transport of trash.	Ongoing
S4: Use efficient irrigation systems & landscape design, water conservation, smart controllers, and source control (Statewide Model Landscape Ordinance; CASQA New Development BMP Handbook SD-12)	Owner	Irrigation systems shall include shutoff valves triggered by a pressure drop to control water loss in the event of broken sprinkler heads or lines. Timers will be used to avoid over watering and watering cycles and duration shall be adjusted seasonally by the landscape maintenance contractor. The landscaping areas will be grouped with plants that have similar water requirements. Native or drought tolerant species shall also be used where appropriate to reduce excess irrigation runoff and promote surface infiltration.	Adjust watering cycles and duration seasonally/quarterly.
S5: Finish grade of landscaped areas at a minimum of 1-2 inches below top of curb, sidewalk, or pavement	Owner	Landscaped areas will be depressed in order to increase retention of stormwater/irrigation water and promote infiltration.	Ongoing

**CITY OF SAN BERNARDINO**  
PUBLIC WORKS DEPARTMENT  
**WOMP SITE MAP**  
**HILLWOOD GATEWAY SOUTH**  
**BUILDING 8**  
**N/W CORNER OF NORMAN RD.**  
**AND LENA RD.,**  
**SAN BERNARDINO, CA**

**PREPARED FOR:**  
HILLWOOD INVESTMENTS  
901 VA PREMONTE, SUITE 175  
ONTARIO, CA 91764  
PHONE: (909) 382-0033  
FAX: (909) 382-0073

**PREPARED BY:**  
**Tai Thienes Engineering, Inc.**  
CIVIL ENGINEERING & LAND SURVEYING  
14349 FIRESTONE BOULEVARD  
LA MIRADA, CALIFORNIA 90638  
PH: (714) 521-4111 FAX: (714) 521-4123

Designed by _____	Approved by _____ Date _____
Checked by _____	Public Works Director R.C.E. _____
Designed by _____	
Checked by _____	
Date _____	
Sheet <b>2</b> of <b>2</b> Sheets	

3575/2 OF 2 SHEET

Last Update: 2/15/22  
01\_3500-3599\_3575\_3575BMPSTEMP.dwg



**Attachment D**  
**WQMP and Stormwater BMP Transfer, Access**  
**and Maintenance Agreement**

RECORDING REQUESTED BY:

WHEN RECORDED RETURN TO:

City of San Bernardino  
Public Works Department, 2nd FLOOR  
201 North "E" Street  
San Bernardino, CA 92401

---

SPACE ABOVE THIS LINE FOR RECORDER'S USE ONLY

**AGREEMENT**

**STORMWATER TREATMENT DEVICE AND CONTROL MEASURE ACCESS  
AND MAINTENANCE AGREEMENT**

**Owner:** Hillwood Investments

**Tract No.:** \_\_\_\_\_ **APN:** 0280-161-03, 05, 06, 07, 08, 09, 10, 11, 12,  
13, 14, 15, 16, 17, 18, 21, 30, 31; 0280-171-  
01, 02, 03, 04, 05, 06, 07, 08, 09, 10, 11

**Address:** Northwest corner of Norman Road and Lena Road, San Bernardino, CA 92408

THIS AGREEMENT is made and entered into this \_\_\_ day of \_\_\_\_\_, 2022, between the City of San Bernardino, a Charter City and municipal corporation, ("City") and Owner. The Owner and the City are sometimes each individually referred to herein as a "Party" and, collectively, as the "Parties."

**RECITALS**

WHEREAS, the Owner owns real property ("Property") in the City specifically described in Exhibits "A" and "B" which are attached hereto and incorporated herein by this reference; and

WHEREAS, at the time of approval of the Owner's development project commonly known as **Hillwood Gateway South Building 8** (the "Project"), the City required the Project to employ on-site control measures to minimize pollutants in urban stormwater runoff; and

WHEREAS, the Owner has chosen to install **one (1) set of underground chambers for infiltration and one (1) hydrodynamic separator** [e.g. vegetated swales, drain inserts, media filters, pervious building material and other control measures] (the "Devices") to minimize pollutants in urban stormwater runoff; and

WHEREAS, the Devices having been installed in accordance with plans and specifications approved by the City; and

WHEREAS, the Devices being installed on private property and draining only private property, are private facilities with all maintenance or replacement therefore being the sole responsibility of the Owner; and

WHEREAS, the Owner is aware that periodic and continuous maintenance including, but not necessarily limited to, filter material replacement and sediment removal as specified in the site's Water Quality Management Plan (WQMP) is required to assure proper performance of the Devices; and

WHEREAS, the Owner is also aware that such maintenance activity will require compliance with all Federal, State and local laws and regulations, including those pertaining to confined space and waste disposal methods in effect at the time such maintenance occurs; and

WHEREAS, California Regional Water Quality Control Board Order No. R8-2010-0036 (NPDES No. CAS 618036) San Bernardino County Municipal Separate Storm Sewer System (MS4) Permit and San Bernardino Municipal Code Section 8.80.208 requires this Stormwater Treatment Device and Control Measure Access and Maintenance Agreement;

NOW, THEREFORE, in consideration of the City's approval of the Project and the mutual promises contained herein, the City of San Bernardino and Owner agree as follows:

#### AGREEMENT

1. The Owner hereby provides the City and its designees with full right of access to the Devices and the Owner's Property in the immediate vicinity of the Devices (a) at any time, upon reasonable notice; or (b) in the event of emergency, as determined by City's Public Works Director with no advance notice; for the purpose of inspecting, sampling and testing of the Devices, and in cases of emergency, to undertake all necessary repairs or other preventative measures at the Owner's expense as provided for in Section 3, below. The City shall make every effort at all times to minimize or avoid interference with the Owner's use of the Property when undertaking such inspections and repairs.
2. The Owner shall diligently maintain the Devices in a manner consistent with the manufacturers' recommended maintenance schedule or the maintenance schedule supplied in the site's WQMP to ensure efficient performance. All reasonable precautions shall be exercised by the Owner and the Owner's representatives in the removal and extraction of materials from the Devices, and the ultimate disposal of the materials in a manner consistent with all applicable laws. As may be requested from time to time by the City, the Owner shall provide the City with documentation identifying the materials removed, the quantity and the location of disposal destinations, as appropriate.
3. In the event the Owner fails to perform the necessary maintenance required by this Agreement within thirty (30) days of being given written notice by the City to do so, setting forth with specificity the action to be taken, the City is authorized to cause any maintenance necessary to be done and charge the entire cost and expense to the Owner, including administrative costs, attorneys' fees and interest thereon at the maximum rate authorized by law. Owner agrees that City may record a lien against the Property twenty (20) days after the City sends Owner the notice of charges if said charges have not been paid in full by Owner.
4. This Agreement shall be recorded in the Official Records of the County of San Bernardino at the expense of the Owner and shall constitute notice to all successors and assigns to the title to the Property of the obligations herein set forth.
5. In the event any action is commenced to enforce or interpret any of the terms or conditions of this Agreement the prevailing Party shall, in addition to any costs and other relief, be entitled to



the recovery of its reasonable attorneys' fees. The costs, salary and expenses of the City Attorney and members of his office in enforcing this Agreement on behalf of the City shall be considered "attorney's fees" for the purposes of this Agreement.

6. It is the intent of the Parties that the burdens and benefits herein undertaken shall constitute equitable servitudes that run with the Property and shall be binding upon future owners of all or any portion of the Property. Any owner's liability hereunder shall terminate at the time it ceases to be an owner of the encumbered Property, except for obligations which accrue prior to the date of transfer by such owner, which shall remain the personal obligation of such owner.
7. Time is of the essence in the performance of this Agreement.
8. Any notice to a Party required or called for in this Agreement shall be served in person, or by deposit in the U.S. Mail, first class postage prepaid, to the address set forth below. Notice(s) shall be deemed effective upon receipt, or seventy-two (72) hours after deposit in the U.S. Mail, whichever is earlier. A Party may change notice address only by providing written notice thereof to the other Party.

CITY

Public Works Director  
City of San Bernardino  
201 North "E" Street, 2<sup>nd</sup> FLOOR  
San Bernardino, CA 92401

OWNER

John M. Magness  
Hillwood Investments  
901 Via Piemonte  
Suite 175  
Ontario, CA 91764

9. This Agreement shall be governed by and construed in accordance with the laws of the State of California.

STORMWATER TREATMENT DEVICE AND CONTROL MEASURE ACCESS  
AND MAINTENANCE AGREEMENT

10. Any amendment to this Agreement shall be in writing and approved by the Public Works Director of the City and signed by the City and the Owner.

I, THE UNDERSIGNED, HAVE A SUFFICIENT OWNERSHIP INTEREST IN THE PROPERTY HEREIN TO CONSENT TO THE IMPOSITION OF A LIEN THEREON, AND HAVE READ AND UNDERSTAND THE FOREGOING AND, BY MY SIGNATURE, AGREE TO COMPLY IN ALL RESPECTS WITH THE CONDITIONS OF THIS AGREEMENT AND **DO HEREBY PERSONALLY GUARANTEE** THE PAYMENT OF THESE FEES AND FURTHER AGREE TO THE PLACEMENT OF A LIEN AS DESCRIBED ABOVE ON THE PROPERTY.

Name of Company **Hillwood Investments**

Signature \_\_\_\_\_

Name John M. Magness Title Senior Vice President

(please print)

Mailing address 901 Via Piemonte, Suite 175

City Ontario State CA Zip 91764

Phone (909) 382-0033

APPROVED AS TO CONTENT:

By: \_\_\_\_\_  
Alex Qishta, Acting Director of Public Works/City Engineer  
Public Works Department  
City of San Bernardino

NOTE: All Signatures Must be Acknowledged by a Notary Public.

**EXHIBIT "A"**  
(LEGAL DESCRIPTION)

SHEET 1 OF 2

THE LAND REFERRED TO HEREIN BELOW IS SITUATED IN THE CITY OF SAN BERNARDINO, COUNTY OF SAN BERNARDINO, STATE OF CALIFORNIA, AND IS DESCRIBED AS FOLLOWS:

*PARCEL 2:*

*PARCEL 2 OF PARCEL MAP NO. 19921, RECORDED ON SEPTEMBER 15, 2020, BOOK 255, PAGES 1 THROUGH 4 OF MAPS, IN THE CITY OF SAN BERNARDINO, STATE OF CALIFORNIA.*

*PARCEL 3:*

*LOTS 30, 31, 32, 33 AND 34, EXCEPT THE EASTERLY 300 FEET OF EACH LOT, OF TRACT NO. 2228, VALLEY TRUCK FARMS NO. 4, AS PER MAP RECORDED IN BOOK 31, PAGE 95 OF MAPS RECORDS OF SAID COUNTY.*

*TOGETHER WITH THAT PORTION OF ROLLINS WAY AS VACATED BY RESOLUTION NO. 2006-421, OF THE CITY OF SAN BERNARDINO, RECORDED DECEMBER 11, 2006, AS INSTRUMENT NO. 2006-0854005, OF OFFICIAL RECORDS OF SAID COUNTY.*

*PARCEL 4:*

*THE EASTERLY 300 FEET, EXCEPT THE EASTERLY 150 FEET, OF LOTS 30, 31, 32, 33 AND 34 OF TRACT NO. 2228 VALLEY TRUCK FARMS NO. 4, AS PER MAP RECORDED IN BOOK 31, PAGE 95 OF MAPS, RECORDS OF SAID COUNTY.*

*PARCEL 5:*

*THE EASTERLY 150 FEET OF LOTS 30, 31, 32, 33, AND 34, OF TRACT NO. 2228, VALLEY TRUCK FARMS NO. 4, AS PER MAP RECORDED IN BOOK 31, PAGE 95 OF MAPS, RECORDS OF SAID COUNTY.*

*PARCEL 6:*

*THE WEST 150 FEET OF THE EAST 300 FEET OF LOTS 67 AND 68, AND THE WEST 150 FEET OF THE EAST 300 FEET OF THE NORTH 2 FEET OF LOT 66, ALL IN TRACT NO. 2228, VALLEY TRUCK FARMS NO. 4, AS PER MAP RECORDED IN BOOK 31, PAGE 95 OF MAPS, RECORDS OF SAID COUNTY.*

*PARCEL 7:*

*A RIGHT OF USAGE IN A COMMON DRIVEWAY ACROSS THE EAST 10 FEET OF THE WEST 150 FEET OF THE EAST 300 FEET OF LOTS 64, 65 AND 66 OF TRACT NO. 2228, VALLEY TRUCK FARMS NO. 4, AS PER MAP RECORDED IN BOOK 31, PAGE 95 OF MAPS, RECORDS OF SAID COUNTY.*

*EXCEPT THEREFROM THE NORTH 2 FEET OF SAID LOT 66.*

**EXHIBIT "A"**  
(LEGAL DESCRIPTION)

SHEET 2 OF 2

*PARCEL NO. 8:*

*THE EASTERLY 150 FEET OF LOTS 64, 65, 66, 67, AND 68, OF TRACT NO. 2228, VALLEY TRUCK FARMS NO. 4, AS PER MAP RECORDED IN BOOK 31, PAGE 95 OF MAPS, RECORDS OF SAID COUNTY.*

*TOGETHER WITH THAT PORTION OF ROLLINS WAY AS VACATED BY RESOLUTION NO. 2006-421, OF THE CITY OF SAN BERNARDINO, RECORDED DECEMBER 11, 2006, AS INSTRUMENT NO. 2006-0854005, OF OFFICIAL RECORDS OF SAID COUNTY.*

*PARCEL 9:*

*THE WEST 150 FEET OF LOT 69 AND THE WEST 150 FEET OF THE NORTHERLY 45 FEET OF LOT 70, TRACT 2228, VALLEY TRUCK FARMS NO. 4, IN THE COUNTY OF SAN BERNARDINO, STATE OF CALIFORNIA, AS PER PLAT RECORDED IN BOOK 31 OF MAPS, PAGE 95, RECORDS OF SAID COUNTY.*

*PARCEL 10*

*THE WEST 300 FEET, EXCEPT THE WEST 150 FEET OF LOTS 69, 70, 71, 72 AND 73 IN TRACT NO. 2228, VALLEY TRUCK FARMS NO. 4, AS PER PLAT RECORDED IN BOOK 31 OF MAPS, PAGE 95, IN THE COUNTY RECORDER OF SAID COUNTY.*

*PARCEL 11*

*LOTS 64, 65, 66, 67 & 68, EXCEPT THE EASTERLY 300 FEET OF EACH, AND LOTS 69, 70, 71, 72 & 73, EXCEPT THE WESTERLY 300 FEET OF EACH, ALL IN TRACT 2228, AS PER PLAT RECORDED IN BOOK 31 OF MAPS, PAGE 95, RECORDS OF SAID COUNTY.*

*PARCEL 12*

*THE WEST 50 FEET OF THE EAST 300 FEET OF LOT 64 AND THE WEST 50 FEET OF THE EAST 300 FEET OF THE SOUTH 78.69 FEET OF LOT 65, TRACT NO. 2228, VALLEY TRUCK FARMS NO.4, IN THE CITY OF SAN BERNARDINO, COUNTY OF SAN BERNARDINO, STATE OF CALIFORNIA, AS PER MAP RECORDED IN BOOK 31, PAGE(S) 95 OF MAPS, IN THE OFFICE OF THE COUNTY RECORDER OF SAID COUNTY.*

*PARCEL 13*

*THE EAST 300 FEET, EXCEPTING THE EAST 150 FEET OF LOTS 64, 65 AND 66, TRACT NO. 2228, VALLEY TRUCK FARMS NO. 4, IN THE CITY OF SAN BERNARDINO, COUNTY OF SAN BERNARDINO, STATE OF CALIFORNIA, AS PER PLAT RECORDED IN BOOK 31, PAGE 95, OF MAPS, IN THE OFFICE OF THE COUNTY RECORDER OF SAID COUNTY.*

*EXCEPTING THEREFROM THE WEST 50 FEET OF THE EAST 300 FEET OF LOT 64 AND THE WEST 50 FEET OF THE EAST 300 FEET OF THE SOUTH 78.69 FEET OF LOT 65 OF THE ABOVE DESCRIBED PROPERTY.*

*ALSO EXCEPTING THEREFROM THE NORTH 2.0 FEET OF LOT 66 OF THE ABOVE DESCRIBED.*

SCALE: 1" = 150'

# EXHIBIT "B"

(MAP/ILLUSTRATION)

SHEET 1 OF 1

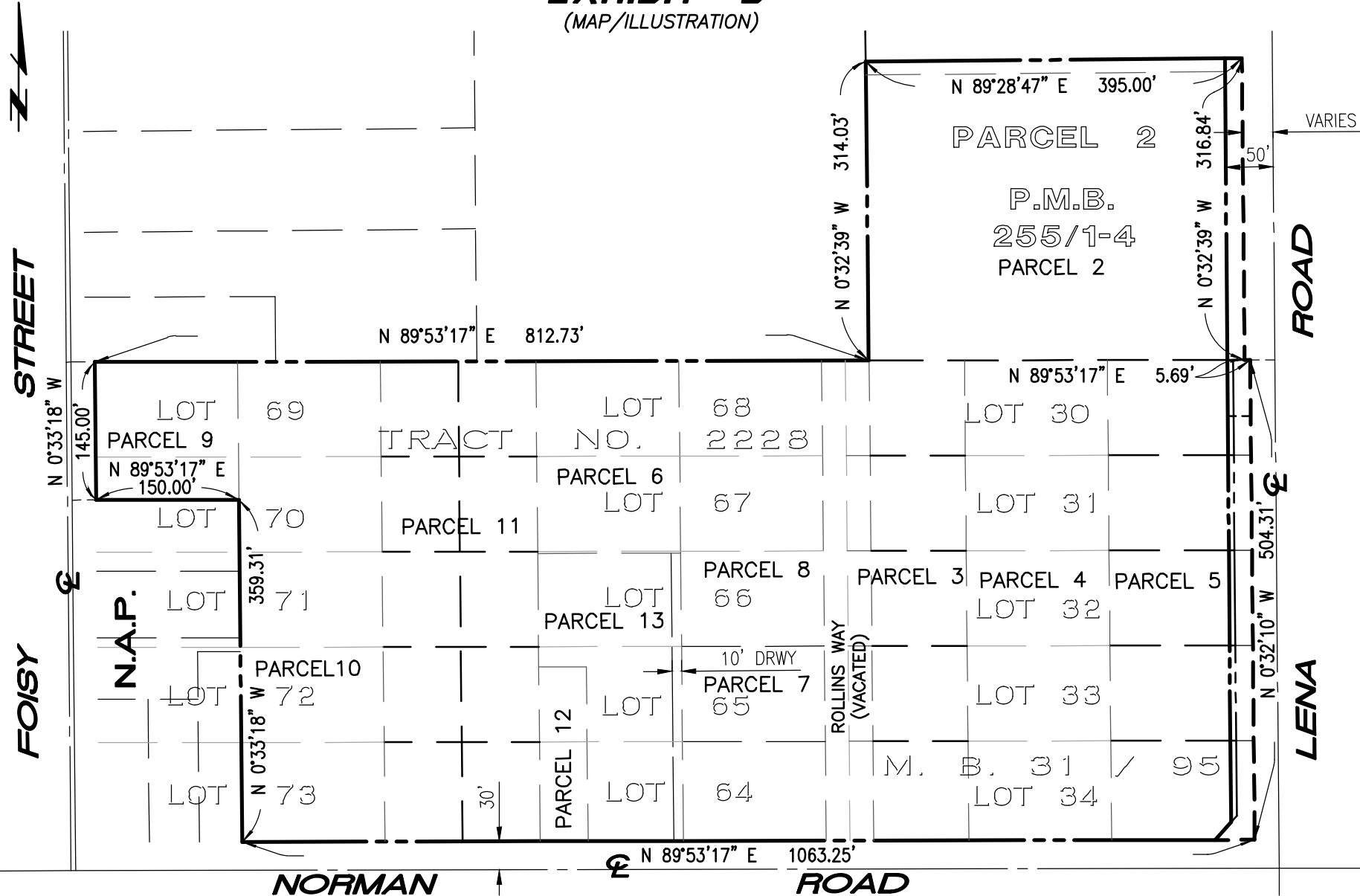

# **Attachment E**

## **Educational Materials**

## General Description

An infiltration basin is a shallow impoundment that is designed to infiltrate stormwater. Infiltration basins store stormwater runoff until it gradually exfiltrates into the underlying soil. Pollutant removal occurs through the infiltration of runoff and the adsorption of pollutants into the soil and vegetation. Additional benefits include:

- Reduced runoff volume and attenuation of peak flows, and
- Facilitated groundwater recharge thus helping to maintain low flows in stream systems.

## Inspection/Maintenance Considerations

The use and regular maintenance of pretreatment BMPs will significantly minimize maintenance requirements for the basin. Installing vegetated swales or a sediment forebay upstream from the infiltration basin can provide effective pretreatment and reduce maintenance.

Spill response procedures and controls should be implemented to prevent spills from reaching the infiltration system. This BMP may require groundwater monitoring, and basins cannot be put into operation until the upstream tributary area is stabilized.

## Advanced BMPs Covered



## Maintenance Concerns

- *Vector Control*
- *Clogged soil or outlet structures*
- *Vegetation/Landscape Maintenance*
- *Groundwater contamination*
- *Accumulation of metals*
- *Aesthetics*

## Targeted Constituents

<i>Sediment</i>	■
<i>Nutrients</i>	■
<i>Trash</i>	■
<i>Metals</i>	■
<i>Bacteria</i>	■
<i>Oil and Grease</i>	■
<i>Organics</i>	■

### Legend (Removal Effectiveness)

- Low ▲ Medium ■ High
- \* Requires Pretreatment

*Note: The removal effectiveness ratings shown in the table are for properly designed, sited, and maintained BMPs; some configurations will have variations in pollutant effectiveness.*



## Description

Non-stormwater discharges (NSWDs) are flows that do not consist entirely of stormwater. Some non-stormwater discharges do not include pollutants and may be discharged to the storm drain if local regulations allow. These include uncontaminated groundwater and natural springs. There are also some non-stormwater discharges that typically do not contain pollutants and may be discharged to the storm drain with conditions. These include: potable water sources, fire hydrant flushing, air conditioner condensate, landscape irrigation drainage and landscape watering, emergency firefighting, etc. as discussed in Section 2.

However there are certain non-stormwater discharges that pose an environmental concern. These discharges may originate from illegal dumping of industrial material or wastes and illegal connections such as internal floor drains, appliances, industrial processes, sinks, and toilets that are illegally connected to the nearby storm drainage system through on-site drainage and piping. These unauthorized discharges (examples of which may include: process waste waters, cooling waters, wash waters, and sanitary wastewater) can carry substances such as paint, oil, fuel and other automotive fluids, chemicals and other pollutants into storm drains.

Non-stormwater discharges will need to be addressed through a combination of detection and elimination. The ultimate goal is to effectively eliminate unauthorized non-stormwater discharges to the stormwater drainage system through implementation of measures to detect, correct, and enforce against illicit connections and illegal discharges of

## Objectives

- *Cover*
- *Contain*
- *Educate*
- *Reduce/Minimize*
- *Product Substitution*

## Targeted Constituents

<i>Sediment</i>	
<i>Nutrients</i>	✓
<i>Trash</i>	
<i>Metals</i>	✓
<i>Bacteria</i>	✓
<i>Oil and Grease</i>	✓
<i>Organics</i>	✓

## Minimum BMPs Covered

 <i>Good Housekeeping</i>	✓
 <i>Preventative Maintenance</i>	
 <i>Spill and Leak Prevention and Response</i>	✓
 <i>Material Handling &amp; Waste Management</i>	
 <i>Erosion and Sediment Controls</i>	
 <i>Employee Training Program</i>	✓
 <i>Quality Assurance Record Keeping</i>	✓





pollutants on streets and into the storm drain system and downstream water bodies.

## **Approach**

Initially the Discharger must make an assessment of non-stormwater discharges to determine which types must be eliminated or addressed through BMPs. The focus of the following approach is the elimination of unauthorized non-stormwater discharges. See other BMP Fact Sheets for activity-specific pollution prevention procedures.

### ***General Pollution Prevention Protocols***

- Implement waste management controls described in SC-34 Waste Handling and Disposal.
- Develop clear protocols and lines of communication for effectively prohibiting non-stormwater discharges, especially those that are not classified as hazardous. These are often not responded to as effectively as they need to be.
- Stencil or demarcate storm drains, where applicable, to prevent illegal disposal of pollutants. Storm drain inlets should have messages such as “Dump No Waste Drains to Stream” or similar stenciled or demarcated next to them to warn against ignorant or unintentional dumping of pollutants into the storm drainage system.
- Manage and control sources of water such as hose bibs, faucets, wash racks, irrigation heads, etc. Identify hoses and faucets in the SWPPP, and post signage for appropriate use.

### ***Non-Stormwater Discharge Investigation Protocols***

Identifying the sources of non-stormwater discharges requires the Discharger to conduct an investigation of the facility at regular intervals. There are several categories of non-stormwater discharges:

- Visible, easily identifiable discharges, typically generated as surface runoff, such as uncontained surface runoff from vehicle or equipment washing; and
- Non-visible, (e.g., subsurface) discharges into the site drainage system through a variety of pathways that are not obvious.

The approach to detecting and eliminating non-stormwater discharges will vary considerably, as discussed below:

#### ***Visible and identifiable discharges***

- Conduct routine inspections of the facilities and of each major activity area and identify visible evidence of unauthorized non-stormwater discharges. This may include:
  - ✓ Visual observations of actual discharges occurring;

- ✓ Evidence of surface staining, discoloring etc. that indicates that discharges have occurred;
  - ✓ Pools of water in low lying areas when a rain event has not occurred; and
  - ✓ Discussions with operations personnel to understand practices that may lead to unauthorized discharges.
- If evidence of non-stormwater discharges is discovered:
- ✓ Document the location and circumstances using Worksheets 5 and 6 (Section 2 of the manual), including digital photos;
  - ✓ Identify and implement any quick remedy or corrective action (e.g., moving uncovered containers inside or to a proper location); and
  - ✓ Develop a plan to eliminate the discharge. Consult the appropriate activity-specific BMP Fact Sheet for alternative approaches to manage and eliminate the discharge.
- Consult the appropriate activity-specific BMP Fact Sheet for alternative approaches to manage and eliminate the discharge. Make sure the facility SWPPP is up-to-date and includes applicable BMPs to address the non-stormwater discharge.

## ***Other Illegal Discharges (Non visible)***

### *Illicit Connections*

- Locate discharges from the industrial storm drainage system to the municipal storm drain system through review of “as-built” piping schematics.
- Isolate problem areas and plug illicit discharge points.
- Locate and evaluate discharges to the storm drain system.
- Visual Inspection and Inventory:
  - ✓ Inventory and inspect each discharge point during dry weather.
  - ✓ Keep in mind that drainage from a storm event can continue for a day or two following the end of a storm and groundwater may infiltrate the underground stormwater collection system.
  - ✓ Non-stormwater discharges are often intermittent and may require periodic inspections.

### *Review Infield Piping*

- A review of the “as-built” piping schematic is a way to determine if there are any connections to the stormwater collection system.

- Inspect the path of loading/unloading area drain inlets and floor drains in older buildings.
- Never assume storm drains are connected to the sanitary sewer system.

### *Monitoring for investigation/detection of illegal discharges*

- If a suspected illegal or unknown discharge is detected, monitoring of the discharge may help identify the content and/or suggest the source. This may be done with a field screening analysis, flow meter measurements, or by collecting a sample for laboratory analysis. Section 5 and Appendix D describe the necessary field equipment and procedures for field investigations.
- Investigative monitoring may be conducted over time. For example if, a discharge is intermittent, then monitoring might be conducted to determine the timing of the discharge to determine the source.
- Investigative monitoring may be conducted over a spatial area. For example, if a discharge is observed in a pipe, then monitoring might be conducted at accessible upstream locations in order to pinpoint the source of the discharge.
- Generally, investigative monitoring requiring collection of samples and submittal for lab analysis requires proper planning and specially trained staff.

### *Smoke Testing*

Smoke testing of wastewater and stormwater collection systems is used to detect connections between the two piping systems. Smoke testing is generally performed at a downstream location and the smoke is forced upstream using blowers to create positive pressure. The advantage to smoke testing is that it can potentially identify multiple potential discharge sources at once.

- Smoke testing uses a harmless, non-toxic smoke cartridges developed specifically for this purpose.
- Smoke testing requires specialized equipment (e.g., cartridges, blowers) and is generally only appropriate for specially trained staff.
- A Standard Operating Procedure (SOP) for smoke testing is highly desirable. The SOP should address the following elements:
  - ✓ Proper planning and notification of nearby residents and emergency services is necessary since introducing smoke into the system may result in false alarms;
  - ✓ During dry weather, the stormwater collection system is filled with smoke and then traced back to sources;

- ✓ Temporary isolation of segments of pipe using sand bags is often needed to force the smoke into leaking pipes; and
- ✓ The appearance of smoke in a waste vent pipe, at a sewer manhole, or even the base of a toilet indicates that there may be a connection between the sanitary and storm water systems.
- Most municipal wastewater agencies will have necessary staff and equipment to conduct smoke testing and they should be contacted if cross connections with the sanitary sewer are suspected. See SC-44 Drainage System Maintenance for more information.

### *Dye Testing*

- Dye testing is typically performed when there is a suspected specific pollutant source and location (i.e., leaking sanitary sewer) and there is evidence of dry weather flows in the stormwater collection system.
- Dye is released at a probable upstream source location, either the facility's sanitary or process wastewater system. The dye must be released with a sufficient volume of water to flush the system.
- Operators then visually examine the downstream discharge points from the stormwater collection system for the presence of the dye.
- Dye testing can be performed informally using commercially available products in order to conduct an initial investigation for fairly obvious cross-connections.
- More detailed dye testing should be performed by properly trained staff and follow SOPs. Specialized equipment such as fluorometers may be necessary to detect low concentrations of dye.
- Most municipal wastewater agencies will have necessary staff and equipment to conduct dye testing and they should be contacted if cross connections with the sanitary sewer are suspected.

### *TV Inspection of Drainage System*

- Closed Circuit Television (CCTV) can be employed to visually identify illicit connections to the industrial storm drainage system. Two types of CCTV systems are available: (1) a small specially designed camera that can be manually pushed on a stiff cable through storm drains to observe the interior of the piping, or (2) a larger remote operated video camera on treads or wheels that can be guided through storm drains to view the interior of the pipe.
- CCTV systems often include a high-pressure water jet and camera on a flexible cable. The water jet cleans debris and biofilm off the inside of pipes so the camera can take video images of the pipe condition.

- CCTV units can detect large cracks and other defects such as offsets in pipe ends caused by root intrusions or shifting substrate.
- CCTV can also be used to detect dye introduced into the sanitary sewer.
- CCTV inspections require specialized equipment and properly trained staff and are generally best left to specialized contractors or municipal public works staff.

## ***Illegal Dumping***

- Substances illegally dumped on streets and into the storm drain systems and creeks may include paints, used oil and other automotive fluids, construction debris, chemicals, fresh concrete, leaves, grass clippings, and pet wastes. These wastes can cause stormwater and receiving water quality problems as well as clog the storm drain system itself.
- Establish a system for tracking incidents. The system should be designed to identify the following:
  - ✓ Illegal dumping hot spots;
  - ✓ Types and quantities (in some cases) of wastes;
  - ✓ Patterns in time of occurrence (time of day/night, month, or year);
  - ✓ Mode of dumping (abandoned containers, “midnight dumping” from moving vehicles, direct dumping of materials, accidents/spills);
  - ✓ An anonymous tip/reporting mechanism; and
  - ✓ Evidence of responsible parties (e.g., tagging, encampments, etc.).
- One of the keys to success of reducing or eliminating illegal dumping is increasing the number of people at the facility who are aware of the problem and who have the tools to at least identify the incident, if not correct it. Therefore, train field staff to recognize and report the incidents.

Once a site has been cleaned:

- Post “No Dumping” signs with a phone number for reporting dumping and disposal.
- Landscaping and beautification efforts of hot spots may also discourage future dumping, as well as provide open space and increase property values.
- Lighting or barriers may also be needed to discourage future dumping.
- See fact sheet SC-11 Spill Prevention, Control, and Cleanup.

## *Inspection*

- Regularly inspect and clean up hot spots and other storm drainage areas where illegal dumping and disposal occurs.
- Conduct field investigations of the industrial storm drain system for potential sources of non-stormwater discharges.
- Pro-actively conduct investigations of high priority areas. Based on historical data, prioritize specific geographic areas and/or incident type for pro-active investigations.



## ***Spill and Leak Prevention and Response***

- On paved surfaces, clean up spills with as little water as possible. Use a rag for small spills, a damp mop for general cleanup, and absorbent material for larger spills. If the spilled material is hazardous, then the used cleanup materials are also hazardous and must be sent to a certified laundry (rags) or disposed of as hazardous waste.
- Never hose down or bury dry material spills. Sweep up the material and dispose of properly.
- Use adsorbent materials on small spills rather than hosing down the spill. Remove the adsorbent materials promptly and dispose of properly.
- For larger spills, a private spill cleanup company or Hazmat team may be necessary.
- See SC-11 Spill Prevention Control and Cleanup.



## ***Employee Training Program***

- Training of technical staff in identifying and documenting illegal dumping incidents is required. The frequency of training must be presented in the SWPPP, and depends on site-specific industrial materials and activities.
- Consider posting a quick reference table near storm drains to reinforce training.
- Train employees to identify non-stormwater discharges and report discharges to the appropriate departments.
- Educate employees about spill prevention and cleanup.
- Well-trained employees can reduce human errors that lead to accidental releases or spills. The employee should have the tools and knowledge to immediately begin cleaning up a spill should one occur. Employees should be familiar with the Spill Prevention Control and Countermeasure Plan. Employees should be able to identify work/jobs with high potential for spills and suggest methods to reduce possibility.
- Determine and implement appropriate outreach efforts to reduce non-permissible non-stormwater discharges.

- Conduct spill response drills annually (if no events occurred) in order to evaluate the effectiveness of the plan.
- When a responsible party is identified, educate the party on the impacts of his or her actions.



## **Quality Assurance and Record Keeping**

### *Performance Evaluation*

- Annually review internal investigation results; assess whether goals were met and what changes or improvements are necessary.
- Obtain feedback from personnel assigned to respond to, or inspect for, illicit connections and illegal dumping incidents.
- Develop document and data management procedures.
- A database is useful for defining and tracking the magnitude and location of the problem.
- Report prohibited non-stormwater discharges observed during the course of normal daily activities so they can be investigated, contained, and cleaned up or eliminated.
- Document that non-stormwater discharges have been eliminated by recording tests performed, methods used, dates of testing, and any on-site drainage points observed.
- Annually document and report the results of the program.
- Maintain documentation of illicit connection and illegal dumping incidents, including significant conditionally exempt discharges that are not properly managed.
- Document training activities.

## **Potential Limitations and Work-Arounds**

Some facilities may have space constraints, limited staffing and time limitations that may preclude implementation of BMPs. Provided below are typical limitations and recommended “work-arounds.”

- Many facilities do not have accurate, up-to-date ‘as-built’ plans or drawings which may be necessary in order to conduct non-stormwater discharge assessments.
  - ✓ Online tools such as Google Earth™ can provide an aerial view of the facility and may be useful in understanding drainage patterns and potential sources of non-stormwater discharges
  - ✓ Local municipal jurisdictions may have useful drainage systems maps.

- Video surveillance cameras are commonly used to secure the perimeter of industrial facilities against break-ins and theft. These surveillance systems may also be useful for capturing illegal dumping activities. Minor, temporary adjustments to the field of view of existing surveillance camera systems to target known or suspected problem areas may be a cost-effective way of capturing illegal dumping activities and identifying the perpetrators.

## **Potential Capital Facility Costs and Operation & Maintenance Requirements**

### ***Facilities***

- Capital facility cost requirements may be minimal unless cross-connections to storm drains are detected.
- Indoor floor drains may require re-plumbing if cross-connections are detected.
- Leaky sanitary sewers will require repair or replacement which can have significant costs depending on the size and industrial activity at the facility.

### ***Maintenance (including administrative and staffing)***

- The primary effort is for staff time and depends on how aggressively a program is implemented.
- Costs for containment, and disposal of any leak or discharge is borne by the Discharger.
- Illicit connections can be difficult to locate especially if there is groundwater infiltration.
- Illegal dumping and illicit connection violations requires technical staff to detect and investigate them.

## **Supplemental Information**

### ***Permit Requirements***

The IGP authorizes certain Non-Storm Water Discharges (NSWDs) provided BMPs are included in the SWPPP and implemented to:

- Reduce or prevent the contact of authorized NSWDs with materials or equipment that are potential sources of pollutants;
- Reduce, to the extent practicable, the flow or volume of authorized NSWDs;
- Ensure that authorized NSWDs do not contain quantities of pollutants that cause or contribute to an exceedance of a water quality standards (WQS); and,



- Reduce or prevent discharges of pollutants in authorized NSWs in a manner that reflects best industry practice considering technological availability and economic practicability and achievability.”

## References and Resources

Center for Watershed Protection, 2004. *Illicit Discharge Detection and Elimination: A Guidance Manual for Program Development and Technical Assessments*, EPA Cooperative Agreement X-82907801-0.

Dublin San Ramon Sanitation District. <http://www.dsrsd.com/www/smoketest.html>.

Orange County Stormwater Program, Best Management Practices for Industrial/Commercial Business Activities. Available online at: <http://ocwatersheds.com/documents/bmp/industrialcommercialbusinessesactivities>.

Sacramento Stormwater Management Program, *Best Management Practices for Industrial Storm Water Pollution Control*, Available online at: <http://www.msa.saccounty.net/sactostormwater/documents/guides/industrial-BMP-manual.pdf>.

Santa Clara Valley Urban Runoff Pollution Prevention Program. <http://www.scvurppp.org>.

Southern California Coastal Water Research Project, 2013. *The California Microbial Source Identification Manual: A Tiered Approach to Identifying Fecal Pollution Sources to Beaches*, Technical Report 804.

The Storm Water Managers Resource Center, <http://www.stormwatercenter.net/>.

US EPA. National Pollutant Discharge Elimination System. Available online at: [http://cfpub.epa.gov/npdes/stormwater/menuofbmps/index.cfm?action=factsheet\\_results&view=specific&bmp=111](http://cfpub.epa.gov/npdes/stormwater/menuofbmps/index.cfm?action=factsheet_results&view=specific&bmp=111).

WEF Press Alexandria, Virginia, 2009. Existing Sewer Evaluation and Rehabilitation: *WEF Manual of Practice No. FD-6 ASCE/EWRI Manuals and Reports on Engineering Practice No. 62, Third Edition*.

# Spill Prevention, Control & Cleanup SC-11

## Description

Many activities that occur at an industrial or commercial site have the potential to cause accidental spills. Preparation for accidental spills, with proper training and reporting systems implemented, can minimize the discharge of pollutants to the environment.

Spills and leaks are one of the largest contributors of stormwater pollutants. Spill prevention and control plans are applicable to any site at which hazardous materials are stored or used. An effective plan should have spill prevention and response procedures that identify hazardous material storage areas, specify material handling procedures, describe spill response procedures, and provide locations of spill clean-up equipment and materials. The plan should take steps to identify and characterize potential spills, eliminate and reduce spill potential, respond to spills when they occur in an effort to prevent pollutants from entering the stormwater drainage system, and train personnel to prevent and control future spills. An adequate supply of spill clean-up materials must be maintained onsite.

## Approach

### General Pollution Prevention Protocols

- Develop procedures to prevent/mitigate spills to storm drain systems.
- Develop and standardize reporting procedures, containment, storage, and disposal activities, documentation, and follow-up procedures.
- Establish procedures and/or controls to minimize spills and leaks. The procedures should address:
  - ✓ Description of the facility, owner and address, activities, chemicals, and quantities present;

### Objectives

- Cover
- Contain
- Educate
- Reduce/Minimize
- Product Substitution

### Targeted Constituents

Sediment	
Nutrients	
Trash	
Metals	✓
Bacteria	
Oil and Grease	✓
Organics	✓

### Minimum BMPs Covered

 Good Housekeeping	
 Preventative Maintenance	
 Spill and Leak Prevention and Response	✓
 Material Handling & Waste Management	
 Erosion and Sediment Controls	
 Employee Training Program	✓
 Quality Assurance Record Keeping	✓



# **Spill Prevention, Control & Cleanup SC-11**

---

- ✓ Facility map of the locations of industrial materials;
  - ✓ Notification and evacuation procedures;
  - ✓ Cleanup instructions;
  - ✓ Identification of responsible departments; and
  - ✓ Identify key spill response personnel.
- Recycle, reclaim, or reuse materials whenever possible. This will reduce the amount of process materials that are brought into the facility.



## ***Spill and Leak Prevention and Response***

### ***Spill Prevention***

- Develop procedures to prevent/mitigate spills to storm drain systems. Develop and standardize reporting procedures, containment, storage, and disposal activities, documentation, and follow-up procedures.
- If illegal dumping is observed at the facility:
  - ✓ Post “No Dumping” signs with a phone number for reporting illegal dumping and disposal. Signs should also indicate fines and penalties applicable for illegal dumping.
  - ✓ Landscaping and beautification efforts may also discourage illegal dumping.
  - ✓ Bright lighting and/or entrance barriers may also be needed to discourage illegal dumping.
- Store and contain liquid materials in such a manner that if the container is ruptured, the contents will not discharge, flow, or be washed into the storm drainage system, surface waters, or groundwater.
- If the liquid is oil, gas, or other material that separates from and floats on water, install a spill control device (such as a tee section) in the catch basins that collect runoff from the storage tank area.



### ***Preventative Maintenance***

- Place drip pans or absorbent materials beneath all mounted taps, and at all potential drip and spill locations during filling and unloading of tanks. Any collected liquids or soiled absorbent materials must be reused/recycled or properly disposed.
- Store and maintain appropriate spill cleanup materials in a location known to all near the tank storage area; and ensure that employees are familiar with the site’s spill control plan and/or proper spill cleanup procedures.

# **Spill Prevention, Control & Cleanup SC-11**

---

- Sweep and clean the storage area monthly if it is paved, *do not hose down the area to a storm drain.*
- Check tanks (and any containment sumps) daily for leaks and spills. Replace tanks that are leaking, corroded, or otherwise deteriorating with tanks in good condition. Collect all spilled liquids and properly dispose of them.
- Label all containers according to their contents (e.g., solvent, gasoline).
- Label hazardous substances regarding the potential hazard (corrosive, radioactive, flammable, explosive, poisonous).
- Prominently display required labels on transported hazardous and toxic materials (per US DOT regulations).
- Identify key spill response personnel.

## *Spill Response*

- Clean up leaks and spills immediately.
- Place a stockpile of spill cleanup materials where it will be readily accessible (e.g., near storage and maintenance areas).
- On paved surfaces, clean up spills with as little water as possible.
  - ✓ Use a rag for small spills, a damp mop for general cleanup, and absorbent material for larger spills.
  - ✓ If the spilled material is hazardous, then the used cleanup materials are also hazardous and must be sent to a certified laundry (rags) or disposed of as hazardous waste.
  - ✓ If possible use physical methods for the cleanup of dry chemicals (e.g., brooms, shovels, sweepers, or vacuums).
- Never hose down or bury dry material spills. Sweep up the material and dispose of properly.
- Chemical cleanups of material can be achieved with the use of adsorbents, gels, and foams. Use adsorbent materials on small spills rather than hosing down the spill. Remove the adsorbent materials promptly and dispose of properly.
- For larger spills, a private spill cleanup company or Hazmat team may be necessary.

# **Spill Prevention, Control & Cleanup SC-11**

---

## *Reporting*

- Report spills that pose an immediate threat to human health or the environment to the Regional Water Quality Control Board or local authority as location regulations dictate.
- Federal regulations require that any oil spill into a water body or onto an adjoining shoreline be reported to the National Response Center (NRC) at 800-424-8802 (24 hour).
- Report spills to 911 for dispatch and clean-up assistance when needed. Do not contact fire agencies directly.
- Establish a system for tracking incidents. The system should be designed to identify the following:
  - ✓ Types and quantities (in some cases) of wastes;
  - ✓ Patterns in time of occurrence (time of day/night, month, or year);
  - ✓ Mode of dumping (abandoned containers, “midnight dumping” from moving vehicles, direct dumping of materials, accidents/spills);
  - ✓ Clean-up procedures; and
  - ✓ Responsible parties.



## ***Employee Training Program***

- Educate employees about spill prevention and cleanup.
- Well-trained employees can reduce human errors that lead to accidental releases or spills:
  - ✓ The employee should have the tools and knowledge to immediately begin cleaning up a spill should one occur; and
  - ✓ Employees should be familiar with the Spill Prevention Control and Countermeasure Plan.
- Employees should be educated about aboveground storage tank requirements. Employees responsible for aboveground storage tanks and liquid transfers should be thoroughly familiar with the Spill Prevention Control and Countermeasure Plan and the plan should be readily available.
- Train employees to recognize and report illegal dumping incidents.

# **Spill Prevention, Control & Cleanup SC-11**

---

## ***Other Considerations (Limitations and Regulations)***

- ❑ State regulations exist for facilities with a storage capacity of 10,000 gallons or more of petroleum to prepare a Spill Prevention Control and Countermeasure (SPCC) Plan (Health & Safety Code Chapter 6.67).
- ❑ State regulations also exist for storage of hazardous materials (Health & Safety Code Chapter 6.95), including the preparation of area and business plans for emergency response to the releases or threatened releases.
- ❑ Consider requiring smaller secondary containment areas (less than 200 sq. ft.) to be connected to the sanitary sewer, prohibiting any hard connections to the storm drain.

## **Requirements**

### ***Costs (including capital and operation & maintenance)***

- ❑ Will vary depending on the size of the facility and the necessary controls.
- ❑ Prevention of leaks and spills is inexpensive. Treatment and/or disposal of contaminated soil or water can be quite expensive.

### ***Maintenance (including administrative and staffing)***

- ❑ Develop spill prevention and control plan, provide and document training, conduct inspections of material storage areas, and supply spill kits.
- ❑ Extra time is needed to properly handle and dispose of spills, which results in increased labor costs.

## **Supplemental Information**

### ***Further Detail of the BMP***

#### ***Reporting***

Record keeping and internal reporting represent good operating practices because they can increase the efficiency of the facility and the effectiveness of BMPs. A good record keeping system helps the facility minimize incident recurrence, correctly respond with appropriate cleanup activities, and comply with legal requirements. A record keeping and reporting system should be set up for documenting spills, leaks, and other discharges, including discharges of hazardous substances in reportable quantities. Incident records describe the quality and quantity of non-stormwater discharges to the storm sewer. These records should contain the following information:

- ❑ Date and time of the incident;
- ❑ Weather conditions;
- ❑ Duration of the spill/leak/discharge;

# **Spill Prevention, Control & Cleanup SC-11**

- Cause of the spill/leak/discharge;
- Response procedures implemented;
- Persons notified; and
- Environmental problems associated with the spill/leak/discharge.

Separate record keeping systems should be established to document housekeeping and preventive maintenance inspections, and training activities. All housekeeping and preventive maintenance inspections should be documented. Inspection documentation should contain the following information:

- Date and time the inspection was performed;
- Name of the inspector;
- Items inspected;
- Problems noted;
- Corrective action required; and
- Date corrective action was taken.

Other means to document and record inspection results are field notes, timed and dated photographs, videotapes, and drawings and maps.

## *Aboveground Tank Leak and Spill Control*

Accidental releases of materials from aboveground liquid storage tanks present the potential for contaminating stormwater with many different pollutants. Materials spilled, leaked, or lost from tanks may accumulate in soils or on impervious surfaces and be carried away by stormwater runoff.

The most common causes of unintentional releases are:

- Installation problems;
- Failure of piping systems (pipes, pumps, flanges, couplings, hoses, and valves);
- External corrosion and structural failure;
- Spills and overfills due to operator error; and
- Leaks during pumping of liquids or gases from truck or rail car to a storage tank or vice versa.

# **Spill Prevention, Control & Cleanup SC-11**

---

Storage of reactive, ignitable, or flammable liquids should comply with the Uniform Fire Code and the National Electric Code. Practices listed below should be employed to enhance the code requirements:

- Tanks should be placed in a designated area.
- Tanks located in areas where firearms are discharged should be encapsulated in concrete or the equivalent.
- Designated areas should be impervious and paved with Portland cement concrete, free of cracks and gaps, in order to contain leaks and spills.
- Liquid materials should be stored in UL approved double walled tanks or surrounded by a curb or dike to provide the volume to contain 10 percent of the volume of all of the containers or 110 percent of the volume of the largest container, whichever is greater. The area inside the curb should slope to a drain.
- For used oil or dangerous waste, a dead-end sump should be installed in the drain.
- All other liquids should be drained to the sanitary sewer if available. The drain must have a positive control such as a lock, valve, or plug to prevent release of contaminated liquids.
- Accumulated stormwater in petroleum storage areas should be passed through an oil/water separator.

Maintenance is critical to preventing leaks and spills. Conduct routine inspections and:

- Check for external corrosion and structural failure.
- Check for spills and overfills due to operator error.
- Check for failure of piping system (pipes, pumps, flanges, coupling, hoses, and valves).
- Check for leaks or spills during pumping of liquids or gases from truck or rail car to a storage facility or vice versa.
- Visually inspect new tank or container installation for loose fittings, poor welding, and improper or poorly fitted gaskets.
- Inspect tank foundations, connections, coatings, and tank walls and piping system. Look for corrosion, leaks, cracks, scratches, and other physical damage that may weaken the tank or container system.
- Frequently relocate accumulated stormwater during the wet season.



# **Spill Prevention, Control & Cleanup SC-11**

---

- Periodically conduct integrity testing by a qualified professional.

## *Vehicle Leak and Spill Control*

Major spills on roadways and other public areas are generally handled by highly trained Hazmat teams from local fire departments or environmental health departments. The measures listed below pertain to leaks and smaller spills at vehicle maintenance shops.

In addition to implementing the spill prevention, control, and clean up practices above, use the following measures related to specific activities:

## *Vehicle and Equipment Maintenance*

- Perform all vehicle fluid removal or changing inside or under cover to prevent the run-on of stormwater and the runoff of spills.
- Regularly inspect vehicles and equipment for leaks, and repair immediately.
- Check incoming vehicles and equipment (including delivery trucks, and employee and subcontractor vehicles) for leaking oil and fluids. Do not allow leaking vehicles or equipment onsite.
- Always use secondary containment, such as a drain pan or drop cloth, to catch spills or leaks when removing or changing fluids.
- Immediately drain all fluids from wrecked vehicles.
- Store wrecked vehicles or damaged equipment under cover.
- Place drip pans or absorbent materials under heavy equipment when not in use.
- Use absorbent materials on small spills rather than hosing down the spill.
- Remove the adsorbent materials promptly and dispose of properly.
- Promptly transfer used fluids to the proper waste or recycling drums. Don't leave full drip pans or other open containers lying around.
- Oil filters disposed of in trashcans or dumpsters can leak oil and contaminate stormwater. Place the oil filter in a funnel over a waste oil recycling drum to drain excess oil before disposal. Oil filters can also be recycled. Ask your oil supplier or recycler about recycling oil filters.
- Store cracked batteries in a non-leaking secondary container. Do this with all cracked batteries, even if you think all the acid has drained out. If you drop a battery, treat it as if it is cracked. Put it into the containment area until you are sure it is not leaking.

# **Spill Prevention, Control & Cleanup SC-11**

---

## *Vehicle and Equipment Fueling*

- Design the fueling area to prevent the run-on of stormwater and the runoff of spills:
  - Cover fueling area if possible.
  - Use a perimeter drain or slope pavement inward with drainage to a sump.
  - Pave fueling area with concrete rather than asphalt.
- If dead-end sump is not used to collect spills, install an oil/water separator.
- Install vapor recovery nozzles to help control drips as well as air pollution.
- Discourage “topping-off” of fuel tanks.
- Use secondary containment when transferring fuel from the tank truck to the fuel tank.
- Use absorbent materials on small spills and general cleaning rather than hosing down the area. Remove the absorbent materials promptly.
- Carry out all Federal and State requirements regarding underground storage tanks, or install above ground tanks.
- Do not use mobile fueling of mobile industrial equipment around the facility; rather, transport the equipment to designated fueling areas.
- Keep your Spill Prevention Control and Countermeasure (SPCC) Plan up-to-date.
- Train employees in proper fueling and cleanup procedures.

## ***Industrial Spill Prevention Response***

For the purposes of developing a spill prevention and response program to meet the stormwater regulations, facility managers should use information provided in this fact sheet and the spill prevention/response portions of the fact sheets in this handbook, for specific activities.

The program should:

- Integrate with existing emergency response/hazardous materials programs (e.g., Fire Department).
- Develop procedures to prevent/mitigate spills to storm drain systems.
- Identify responsible departments.

# **Spill Prevention, Control & Cleanup SC-11**

---

- Develop and standardize reporting procedures, containment, storage, and disposal activities, documentation, and follow-up procedures.
- Address spills at municipal facilities, as well as public areas.
- Provide training concerning spill prevention, response and cleanup to all appropriate personnel.

## **References and Resources**

California's Nonpoint Source Program Plan. <http://www.swrcb.ca.gov/nps/index.html>.

Clark County Storm Water Pollution Control Manual. Available online at: <http://www.co.clark.wa.us/pubworks/bmpman.pdf>.

King County Storm Water Pollution Control Manual. Available online at: <http://dnr.metrokc.gov/wlr/dss/spcm.htm>.

Orange County Stormwater Program, Best Management Practices for Industrial/Commercial Business Activities. Available online at: <http://ocwatersheds.com/documents/bmp/industrialcommercialbusinessesactivities>

Santa Clara Valley Urban Runoff Pollution Prevention Program. <http://www.scvurppp.org>.

The Stormwater Managers Resource Center. <http://www.stormwatercenter.net/>.

## Description

The loading/unloading of materials usually takes place outside on docks or terminals; therefore, materials spilled, leaked, or lost during loading/unloading may collect in the soil or on other surfaces and have the potential to be carried away by wind, stormwater runoff or when the area is cleaned. Additionally, rainfall may wash pollutants from machinery used to unload or move materials. Implementation of the following protocols will prevent or reduce the discharge of pollutants to stormwater from outdoor loading/unloading of materials.

## Approach

Reduce potential for pollutant discharge through source control pollution prevention and BMP implementation. Successful implementation depends on effective training of employees on applicable BMPs and general pollution prevention strategies and objectives.

### General Pollution Prevention Protocols

- Park tank trucks or delivery vehicles in designated areas so that spills or leaks can be contained.
- Limit exposure of material to rainfall whenever possible.
- Prevent stormwater run-on.
- Check equipment regularly for leaks.



### Good Housekeeping

- Develop an operations plan that describes procedures for loading and/or unloading.
- Conduct loading and unloading in dry weather if possible.

## Objectives

- Cover
- Contain
- Educate
- Reduce/Minimize
- Product Substitution

## Targeted Constituents

Sediment	✓
Nutrients	✓
Trash	
Metals	✓
Bacteria	
Oil and Grease	✓
Organics	✓

## Minimum BMPs Covered

 Good Housekeeping	✓
 Preventative Maintenance	
 Spill and Leak Prevention and Response	✓
 Material Handling & Waste Management	✓
 Erosion and Sediment Controls	
 Employee Training Program	✓
 Quality Assurance Record Keeping	✓



- ❑ Cover designated loading/unloading areas to reduce exposure of materials to rain.
- ❑ Consider placing a seal or door skirt between delivery vehicles and building to prevent exposure to rain.
- ❑ Design loading/unloading area to prevent stormwater run-on, which would include grading or berming the area, and position roof downspouts so they direct stormwater away from the loading/unloading areas.
- ❑ Have employees load and unload all materials and equipment in covered areas such as building overhangs at loading docks if feasible.
- ❑ Load/unload only at designated loading areas.
- ❑ Use drip pans underneath hose and pipe connections and other leak-prone spots during liquid transfer operations, and when making and breaking connections. Several drip pans should be stored in a covered location near the liquid transfer area so that they are always available, yet protected from precipitation when not in use. Drip pans can be made specifically for railroad tracks. Drip pans must be cleaned periodically, and drip collected materials must be disposed of properly.
- ❑ Pave loading areas with concrete instead of asphalt.
- ❑ Avoid placing storm drains inlets in the area.
- ❑ Grade and/or berm the loading/unloading area with drainage to sump; regularly remove materials accumulated in sump.



## ***Spill Response and Prevention Procedures***

- ❑ Keep your spill prevention and control plan up-to-date or have an emergency spill cleanup plan readily available, as applicable.
- ❑ Contain leaks during transfer.
- ❑ Store and maintain appropriate spill cleanup materials in a location that is readily accessible and known to all employees.
- ❑ Ensure that employees are familiar with the site's spill control plan and proper spill cleanup procedures.
- ❑ Use drip pans or comparable devices when transferring oils, solvents, and paints.



## ***Material Handling and Waste Management***

- ❑ Spot clean leaks and drips routinely to prevent runoff of spillage.
- ❑ Do not pour liquid wastes into floor drains, sinks, outdoor storm drain inlets, or other storm drains or sewer connections.

- ❑ Do not put used or leftover cleaning solutions, solvents, and automotive fluids in the storm drain or sanitary sewer.
- ❑ Collect leaking or dripping fluids in drip pans or containers. Fluids are easier to recycle if kept separate.
- ❑ Promptly transfer used fluids to the proper waste or recycling drums. Do not leave drip pans or other open containers lying around.
- ❑ Minimize the possibility of stormwater pollution from outside waste receptacles by doing at least one of the following:
  - ✓ Use only watertight waste receptacle(s) and keep the lid(s) closed.
  - ✓ Grade and pave the waste receptacle area to prevent run-on of stormwater.
  - ✓ Install a roof over the waste receptacle area.
  - ✓ Install a low containment berm around the waste receptacle area.
  - ✓ Use and maintain drip pans under waste receptacles.
- ❑ Post “no littering” signs.
- ❑ Perform work area clean-up and dry sweep after daily operations.



## ***Employee Training Program***

- ❑ Train employees (e.g., fork lift operators) and contractors on proper spill containment and cleanup.
- ❑ Have employees trained in spill containment and cleanup present during loading/unloading.
- ❑ Train employees in proper handling techniques during liquid transfers to avoid spills.
- ❑ Make sure forklift operators are properly trained on loading and unloading procedures.



## ***Quality Assurance and Record Keeping***

- ❑ Keep accurate maintenance logs that document activities performed, quantities of materials removed, and improvement actions.
- ❑ Keep accurate logs of spill response actions that document what was spilled, how it was cleaned up, and how the waste was disposed.
- ❑ Establish procedures to complete logs and file them in the central office.
- ❑ Keep accurate logs of daily clean-up operations.

## Potential Limitations and Work-Arounds

Some facilities may have space constraints, limited staffing and time limitations that may preclude implementation of BMPs. Provided below are typical limitations and recommended “work-arounds.”

- Space and time limitations may preclude all transfers from being performed indoors or under cover.
  - ✓ Designate specific areas for outdoor loading and unloading.
  - ✓ Require employees to understand and follow spill and leak prevention BMPs.
- It may not be possible to conduct transfers only during dry weather.
  - ✓ Limit materials and equipment rainfall exposure to all extents practicable.
  - ✓ Require employees to understand and follow spill and leak prevention BMPs.

## Potential Capital Facility Costs and Operation & Maintenance Requirements

### *Facilities*

Many facilities will already have indoor or covered areas where loading/unloading takes place and will require no additional capital expenditures.

If outdoor activities are required, construction of berms or other means to retain spills and leaks may require appropriate constructed systems for containment. These containment areas may require significant new capital investment.

Capital investments will likely be required at some sites if adequate cover and containment facilities do not exist and can vary significantly depending upon site conditions.

### *Maintenance*

Most of the operations and maintenance activities associated with implementing this BMP are integrally linked to routine operations as previously described. Therefore additional O&M is not required.

- Conduct regular inspections and make repairs and improvements as necessary.
- Check loading and unloading equipment regularly for leaks.
- Conduct regular broom dry-sweeping of area. Do not wash with water.

## Supplemental Information

### *Loading and Unloading of Liquids*

- Loading or unloading of liquids should occur in the manufacturing building so that any spills that are not completely retained can be discharged to the sanitary sewer,

treatment plant, or treated in a manner consistent with local sewer authorities and permit requirements.

- For loading and unloading tank trucks to above and below ground storage tanks, the following procedures should be used:
  - ✓ The area where the transfer takes place should be paved. If the liquid is reactive with the asphalt, Portland cement should be used to pave the area.
  - ✓ The transfer area should be designed to prevent run-on of stormwater from adjacent areas. Sloping the pad and using a curb, like a speed bump, around the uphill side of the transfer area should reduce run-on.
  - ✓ The transfer area should be designed to prevent runoff of spilled liquids from the area. Sloping the area to a drain should prevent runoff. The drain should be connected to a dead-end sump or to the sanitary sewer. A positive control valve should be installed on the drain.
  
- For transfer from rail cars to storage tanks that must occur outside, use the following procedures:
  - ✓ Drip pans should be placed at locations where spillage may occur, such as hose connections, hose reels, and filler nozzles. Use drip pans when making and breaking connections.
  - ✓ Drip pan systems should be installed between the rails to collect spillage from tank cars.

## References and Resources

Minnesota Pollution Control Agency, *Industrial Stormwater Best Management Practices Guidebook BMP 26 Fueling and Liquid Loading/Unloading Operations*. Available online at: <http://www.pca.state.mn.us/index.php/view-document.html?gid=10557>.

New Jersey Department of Environmental Protection, 2013. *Basic Industrial Stormwater General Permit Guidance Document NJPDES General Permit No NJ0088315*. Available online at: [http://www.nj.gov/dep/dwq/pdf/5G2\\_guidance\\_color.pdf](http://www.nj.gov/dep/dwq/pdf/5G2_guidance_color.pdf).

Orange County Stormwater Program, Best Management Practices for Industrial/Commercial Business Activities. Available online at: <http://ocwatersheds.com/documents/bmp/industrialcommercialbusinessesactivities>.

Oregon Department of Environmental Quality, 2013. *Industrial Stormwater Best Management Practices Manual- BMP 26 Fueling and Liquid Loading/Unloading Operations*. Available online at: <http://www.deq.state.or.us/wq/wqpermit/docs/IndBMP021413.pdf>.



Sacramento Stormwater Management Program, *Best Management Practices for Industrial Storm Water Pollution Control*. Available online at: <http://www.msa.saccounty.net/sactostormwater/documents/guides/industrial-BMP-manual.pdf>.

Sacramento County Environmental Management Stormwater Program: *Best Management Practices*. Available online at: <http://www.emd.saccounty.net/EnvHealth/Stormwater/Stormwater-BMPs.html>.

Santa Clara Valley Urban Runoff Pollution Prevention Program. <http://www.scvurppp-w2k.com/>.

US EPA. National Pollutant Discharge Elimination System – Industrial Fact Sheet Series for Activities Covered by EPA’s Multi Sector General Permit. Available online at: <http://cfpub.epa.gov/npdes/stormwater/swsectors.cfm>.

# Outdoor Equipment Operations SC-32

## Description

Outside process equipment operations and maintenance can contaminate stormwater runoff. Activities, such as grinding, painting, coating, sanding, degreasing or parts cleaning, landfills and waste piles, and solid waste treatment and disposal are examples of process operations that can lead to contamination of stormwater runoff. The targeted constituents will vary for each site depending on the operation being performed.

## Approach

Implement source control BMPs to limit exposure of outdoor equipment to direct precipitation and stormwater run-on. Refer to SC-22 Vehicle and Equipment Repair for additional information.

## General Pollution Prevention Protocols

- Perform the activity during dry periods whenever possible.
- Install secondary containment measures where leaks and spills may occur.
- Use non-toxic chemicals for maintenance and minimize or eliminate the use of solvents.
- Connect process equipment area to public sanitary sewer or facility wastewater treatment system when possible. Some jurisdictions require that secondary containment areas be connected to the sanitary sewer, prohibiting any hard connections to the storm drain.



### Good Housekeeping

- Manage materials and waste properly (see Material Handling and Waste Management) to reduce adverse impacts on stormwater quality.

## Objectives

- Cover
- Contain
- Educate
- Reduce/Minimize

## Targeted Constituents

Sediment	✓
Nutrients	✓
Trash	✓
Metals	✓
Bacteria	✓
Oil and Grease	✓
Organics	✓

## Minimum BMPs Covered

 Good Housekeeping	✓
 Preventative Maintenance	✓
 Spill and Leak Prevention and Response	✓
 Material Handling & Waste Management	✓
 Erosion and Sediment Controls	
 Employee Training Program	✓
 Quality Assurance Record Keeping	✓



CALIFORNIA STORMWATER  
QUALITY ASSOCIATION®

# Outdoor Equipment Operations SC-32

---

- Cover the work area with a permanent roof if possible.
- Use drop cloths for sanding and painting operations.
- Use a vacuum for fine particle clean-up in pavement cracks and crevices.
- Minimize contact of stormwater with outside process equipment operations through berming and drainage routing (run-on prevention).
- "Spot clean" leaks and drips routinely. Leaks are not cleaned up until the absorbent is picked up and disposed of properly.
- Paint signs on storm drain inlets to indicate that they are not to receive liquid or solid wastes.
- Use roll down or permanent walls when windy/breezy to prevent wind transport of particulates/pollutants.



## ***Preventative Maintenance***

- Design outdoor equipment areas to prevent stormwater runoff and spills. Use a perimeter drain or slope pavement inward with drainage to sump.
- Dry clean the work area regularly. Do not wash outdoor equipment with water if there is a direct connection to the storm drain.
- Pave area with concrete rather than asphalt.
- Inspect outdoor equipment regularly for leaks or spills. Also check for structural failure, spills and overfills due to operator error, and/or failure of piping system.
- Inspect and clean, if necessary, storm drain inlets and catch basins within the outdoor equipment area before October 1 each year.



## ***Spill Response and Prevention Procedures***

- Keep your Spill Prevention Control and Countermeasure (SPCC) Plan up-to-date.
- Have employees trained in emergency spill cleanup procedures present when dangerous waste, liquid chemicals, or other wastes are delivered.
- Place a stockpile of spill cleanup materials where it will be readily accessible.
- Prevent operator errors by using engineering safe guards and thus reducing accidental releases of pollutant.



## ***Material Handling and Waste Management***

# Outdoor Equipment Operations SC-32

---

- ❑ Do not pour liquid wastes into floor drains, sinks, outdoor storm drain inlets, or other storm drain or sewer connections.
- ❑ Collect leaking or dripping fluids in drip pans or containers. Fluids are easier to recycle if kept separate.
- ❑ Promptly transfer used fluids to the proper waste or recycling drums. Do not leave drip pans or other open containers lying around.
- ❑ Minimize the possibility of stormwater pollution from outside waste receptacles by doing at least one of the following:
  - ✓ Use only watertight waste receptacle(s) and keep the lid(s) closed.
  - ✓ Grade and pave the waste receptacle area to prevent run-on of stormwater.
  - ✓ Install a roof over the waste receptacle area.



## ***Employee Training Program***

- ❑ Educate employees about pollution prevention measures and goals.
- ❑ Train employees on proper equipment operation and maintenance procedures.
- ❑ Train all employees upon hiring and annually thereafter on proper methods for handling and disposing of waste. Ensure that all employees understand stormwater discharge prohibitions, wastewater discharge requirements, and these best management practices.
- ❑ Use a training log or similar method to document training.
- ❑ Ensure that employees are familiar with the site's spill control plan and/or proper spill cleanup procedures.



## ***Quality Assurance and Record Keeping***

- ❑ Keep accurate maintenance logs that document minimum BMP activities performed for outdoor equipment, types and quantities of materials removed and disposed of, and any improvement actions.
- ❑ Keep accurate logs of spill response actions that document what was spilled, how it was cleaned up, and how the waste was disposed.
- ❑ Establish procedures to complete logs and file them in the central office.

## **Potential Limitations and Work-Arounds**

Some facilities may have space constraints, limited staffing and time limitations that may preclude implementation of BMPs. Provided below are typical limitations and recommended “work-arounds.”

# **Outdoor Equipment Operations SC-32**

---

- Providing cover over outdoor equipment may be impractical or cost-prohibitive.
  - ✓ Operate outdoor equipment only during periods of dry weather.
- Regular operations and time limitations may require outdoor activities during wet weather.
  - ✓ Designate specific areas for outdoor activities.
  - ✓ Allow time for work area clean-up after each shift.
  - ✓ Require employees to understand and follow preventive maintenance and spill and leak prevention BMPs.
  - ✓ Design and install secondary containment and good housekeeping BMPs for outdoor equipment area.
- Storage sheds often must meet building and fire code requirements.

## **Potential Capital Facility Costs and Operation & Maintenance Requirements**

### ***Facilities***

- Many facilities will already have indoor covered areas where vehicle and equipment repairs take place and will require no additional capital expenditures.
- If outdoor activities are required, construction of berms or other means to retain spills and leaks may require appropriate constructed systems for containment. These containment areas may require significant new capital investment.
- Capital investments will likely be required at some sites if adequate cover and containment facilities do not exist and can vary significantly depending upon site conditions.

### ***Maintenance***

- Most of the operations and maintenance activities associated with implementing this BMP are integrally linked to routine operations as previously described. Therefore additional O&M is not required.
- For facilities responsible for pre-treating their wastewater prior to discharging, the proper functioning of structural treatment system is an important maintenance consideration.
- Routine cleanout of oil and grease is required for the devices to maintain their effectiveness, usually at least once a month. During periods of heavy rainfall, cleanout is required more often to ensure pollutants are not washed through the trap. Sediment removal is also required on a regular basis to keep the device working efficiently.

# Outdoor Equipment Operations SC-32

---

## References and Resources

Minnesota Pollution Control Agency. *Industrial Stormwater Best Management Practices Guidebook BMP 26 Fueling and Liquid Loading/Unloading Operations*. Available online at: <http://www.pca.state.mn.us/index.php/view-document.html?gid=10557>.

New Jersey Department of Environmental Protection, 2013. *Basic Industrial Stormwater General Permit Guidance Document NJPDES General Permit No NJ0088315*. Available online at: [http://www.nj.gov/dep/dwq/pdf/5G2\\_guidance\\_color.pdf](http://www.nj.gov/dep/dwq/pdf/5G2_guidance_color.pdf).

Orange County Stormwater Program, Best Management Practices for Industrial/Commercial Business Activities. Available online at: <http://ocwatersheds.com/documents/bmp/industrialcommercialbusinessesactivities>.

Oregon Department of Environmental Quality, *Industrial Stormwater Best Management Practices Manual- BMP 26 Fueling and Liquid Loading/Unloading Operations*, February 2013. Available online at: <http://www.deq.state.or.us/wq/wqpermit/docs/IndBMP021413.pdf>.

Sacramento Stormwater Management Program. *Best Management Practices for Industrial Storm Water Pollution Control*. Available online at: <http://www.msa.saccounty.net/sactostormwater/documents/guides/industrial-BMP-manual.pdf>.

Sacramento County Environmental Management Stormwater Program: Best Management Practices. Available online at: <http://www.emd.saccounty.net/EnvHealth/Stormwater/Stormwater-BMPs.html>.

Santa Clara Valley Urban Runoff Pollution Prevention Program. <http://www.scvurppp-w2k.com/>

US EPA. National Pollutant Discharge Elimination System – Industrial Fact Sheet Series for Activities Covered by EPA’s Multi Sector General Permit. Available online at: <http://cfpub.epa.gov/npdes/stormwater/swsectors.cfm>.

## Description

Improper storage and handling of solid wastes can allow toxic compounds, oils and greases, heavy metals, nutrients, suspended solids, and other pollutants to enter stormwater runoff. The discharge of pollutants to stormwater from waste handling and disposal can be prevented and reduced by tracking waste generation, storage, and disposal; reducing waste generation and disposal through source reduction, reuse, and recycling; and preventing run-on and runoff.

## Approach

Reduce potential for pollutant discharge through source control pollution prevention and BMP implementation. Successful implementation depends on effective training of employees on applicable BMPs and general pollution prevention strategies and objectives.

### General Pollution Prevention Protocols

- Accomplish reduction in the amount of waste generated using the following source controls:
  - ✓ Production planning and sequencing;
  - ✓ Process or equipment modification;
  - ✓ Raw material substitution or elimination;
  - ✓ Loss prevention and housekeeping;
  - ✓ Waste segregation and separation; and
  - ✓ Close loop recycling.
- Establish a material tracking system to increase awareness about material usage. This may reduce spills and minimize contamination, thus reducing the amount of waste produced.
- Recycle materials whenever possible.

## Objectives

- Cover
- Contain
- Educate
- Reduce/Minimize
- Product Substitution

## Targeted Constituents

Sediment	
Nutrients	
Trash	
Metals	✓
Bacteria	✓
Oil and Grease	✓
Organics	✓

## Minimum BMPs Covered

 Good Housekeeping	✓
 Preventative Maintenance	✓
 Spill and Leak Prevention and Response	✓
 Material Handling & Waste Management	✓
 Erosion and Sediment Controls	
 Employee Training Program	✓
 Quality Assurance Record Keeping	✓



- Use the entire product before disposing of the container.
- To the extent possible, store wastes under cover or indoors after ensuring all safety concerns such as fire hazard and ventilation are addressed.
- Provide containers for each waste stream at each work station. Allow time after shift to clean area.



## ***Good Housekeeping***

- Cover storage containers with leak proof lids or some other means. If waste is not in containers, cover all waste piles (plastic tarps are acceptable coverage) and prevent stormwater run-on and runoff with a berm. The waste containers or piles must be covered except when in use.
- Use drip pans or absorbent materials whenever grease containers are emptied by vacuum trucks or other means. Grease cannot be left on the ground. Collected grease must be properly disposed of as garbage.
- Dispose of rinse and wash water from cleaning waste containers into a sanitary sewer if allowed by the local sewer authority. Do not discharge wash water to the street or storm drain. Clean in a designated wash area that drains to a clarifier.
- Transfer waste from damaged containers into safe containers.
- Take special care when loading or unloading wastes to minimize losses. Loading systems can be used to minimize spills and fugitive emission losses such as dust or mist. Vacuum transfer systems can minimize waste loss.
- Keep the waste management area clean at all times by sweeping and cleaning up spills immediately.
- Use dry methods when possible (e.g., sweeping, use of absorbents) when cleaning around restaurant/food handling dumpster areas. If water must be used after sweeping/using absorbents, collect water and discharge through grease interceptor to the sewer.
- Stencil or demarcate storm drains on the facility's property with prohibitive message regarding waste disposal.
- Cover waste piles with temporary covering material such as reinforced tarpaulin, polyethylene, polyurethane, polypropylene or hypalon.
- If possible, move the activity indoor after ensuring all safety concerns such as fire hazard and ventilation are addressed.



## ***Preventative Maintenance***

- Prevent stormwater run-on from entering the waste management area by enclosing the area or building a berm around the area.
- Prevent waste materials from directly contacting rain.



- ❑ Cover waste piles with temporary covering material such as reinforced tarpaulin, polyethylene, polyurethane, polypropylene or hypalon.
- ❑ Cover the area with a permanent roof if feasible.
- ❑ Cover dumpsters to prevent rain from washing waste out of holes or cracks in the bottom of the dumpster.
- ❑ Check waste containers weekly for leaks and to ensure that lids are on tightly. Replace any that are leaking, corroded, or otherwise deteriorating.
- ❑ Sweep and clean the waste management area regularly. Use dry methods when possible (e.g., sweeping, vacuuming, use of absorbents) when cleaning around restaurant/food handling dumpster areas. If water must be used after sweeping/using absorbents, collect water and discharge through grease interceptor to the sewer.
- ❑ Inspect and replace faulty pumps or hoses regularly to minimize the potential of releases and spills.
- ❑ Repair leaking equipment including valves, lines, seals, or pumps promptly.



## ***Spill Response and Prevention Procedures***

- ❑ Keep your spill prevention and plan up-to-date.
- ❑ Have an emergency plan, equipment and trained personnel ready at all times to deal immediately with major spills.
- ❑ Collect all spilled liquids and properly dispose of them.
- ❑ Store and maintain appropriate spill cleanup materials in a location known to all near the designated wash area.
- ❑ Ensure that vehicles transporting waste have spill prevention equipment that can prevent spills during transport. Spill prevention equipment includes:
  - ✓ Vehicles equipped with baffles for liquid waste; and
  - ✓ Trucks with sealed gates and spill guards for solid waste.



## ***Material Handling and Waste Management***

### *Litter Control*

- ❑ Post “No Littering” signs and enforce anti-litter laws.
- ❑ Provide a sufficient number of litter receptacles for the facility.
- ❑ Clean out and cover litter receptacles frequently to prevent spillage.

### *Waste Collection*

- ❑ Keep waste collection areas clean.

- Inspect solid waste containers for structural damage regularly. Repair or replace damaged containers as necessary.
- Secure solid waste containers; containers must be closed tightly when not in use.
- Do not fill waste containers with washout water or any other liquid.
- Ensure that only appropriate solid wastes are added to the solid waste container. Certain wastes such as hazardous wastes, appliances, fluorescent lamps, pesticides, etc., may not be disposed of in solid waste containers (see chemical/ hazardous waste collection section below).
- Do not mix wastes; this can cause chemical reactions, make recycling impossible, and complicate disposal. Affix labels to all waste containers.

### *Chemical/Hazardous Wastes*

- Select designated hazardous waste collection areas on-site.
- Store hazardous materials and wastes in covered containers and protect them from vandalism.
- Place hazardous waste containers in secondary containment.
- Make sure that hazardous waste is collected, removed, and disposed of only at authorized disposal areas.
- Hazardous waste cannot be reused or recycled; it must be disposed of by a licensed hazardous waste hauler.



### **Employee Training Program**

- Educate employees about pollution prevention measures and goals.
- Train employees how to properly handle and dispose of waste using the source control BMPs described above.
- Train employees and subcontractors in proper hazardous waste management.
- Use a training log or similar method to document training.
- Ensure that employees are familiar with the site's spill control plan and/or proper spill cleanup procedures.



### **Quality Assurance and Record Keeping**

- Keep accurate maintenance logs that document minimum BMP activities performed for waste handling and disposal, types and quantities of waste disposed of, and any improvement actions.
- Keep accurate logs of spill response actions that document what was spilled, how it was cleaned up, and how the waste was disposed.

- Establish procedures to complete logs and file them in the central office.

## **Potential Capital Facility Costs and Operation & Maintenance Requirements**

### ***Facilities***

- Capital costs will vary substantially depending on the size of the facility and the types of waste handled. Significant capital costs may be associated with reducing wastes by modifying processes or implementing closed-loop recycling.
- Many facilities will already have indoor covered areas where waste materials will be stored and will require no additional capital expenditures for providing cover.
- If outdoor storage of wastes is required, construction of berms or other means to prevent stormwater run-on and runoff may require appropriate constructed systems for containment.
- Capital investments will likely be required at some sites if adequate cover and containment facilities do not exist and can vary significantly depending upon site conditions.

### ***Maintenance***

- Check waste containers weekly for leaks and to ensure that lids are on tightly. Replace any that are leaking, corroded, or otherwise deteriorating.
- Sweep and clean the waste management area regularly. Use dry methods when possible (e.g., sweeping, use of absorbents) when cleaning around restaurant/food handling dumpster areas. If water must be used after sweeping/using absorbents, collect water and discharge through grease interceptor to the sewer.
- Inspect and replace faulty pumps or hoses regularly to minimize the potential of releases and spills.
- Repair leaking equipment including valves, lines, seals, or pumps promptly.

## **References and Resources**

Minnesota Pollution Control Agency, *Industrial Stormwater Best Management Practices Guidebook*. Available online at: <http://www.pca.state.mn.us/index.php/view-document.html?gid=10557>.

New Jersey Department of Environmental Protection, 2013. *Basic Industrial Stormwater General Permit Guidance Document NJPDES General Permit No NJ0088315*, Revised. Available online at: [http://www.nj.gov/dep/dwq/pdf/5G2\\_guidance\\_color.pdf](http://www.nj.gov/dep/dwq/pdf/5G2_guidance_color.pdf).

Orange County Stormwater Program, *Best Management Practices for Industrial/Commercial Business Activities*. Available online at: <http://ocwatersheds.com/documents/bmp/industrialcommercialbusinessactivities>

Oregon Department of Environmental Quality, 2013. *Industrial Stormwater Best Management Practices Manual- BMP 26 Fueling and Liquid Loading/Unloading Operations*. Available online at:  
<http://www.deq.state.or.us/wq/wqpermit/docs/IndBMP021413.pdf>.

Sacramento Stormwater Management Program. *Best Management Practices for Industrial Storm Water Pollution Control*. Available online at:  
<http://www.msa.saccounty.net/sactostormwater/documents/guides/industrial-BMP-manual.pdf>.

Sacramento County Environmental Management Stormwater Program: Best Management Practices. Available online at:  
<http://www.emd.saccounty.net/EnvHealth/Stormwater/Stormwater-BMPs.html>.

Santa Clara Valley Urban Runoff Pollution Prevention Program. <http://www.scvurppp-w2k.com/>

US EPA. National Pollutant Discharge Elimination System – Industrial Fact Sheet Series for Activities Covered by EPA’s Multi Sector General Permit. Available online at:  
<http://cfpub.epa.gov/npdes/stormwater/swsectors.cfm>.

## Description

Promote the use of less harmful products and products that contain little or no TMDL and 303(d) list pollutants. Alternatives exist for most product classes including chemical fertilizers, pesticides, cleaning solutions, janitorial chemicals, automotive and paint products, and consumables (batteries, fluorescent lamps).

## Approach

Pattern a new program after the many established programs around the state and country. Integrate this best management practice as much as possible with existing programs at your facility.

Develop a comprehensive program based on:

- The “Precautionary Principle,” which is an alternative to the "Risk Assessment" model that says it's acceptable to use a potentially harmful product until physical evidence of its harmful effects are established and deemed too costly from an environmental or public health perspective. For instance, a risk assessment approach might say it's acceptable to use a pesticide until there is direct proof of an environmental impact. The Precautionary Principle approach is used to evaluate whether a given product is safe, whether it is really necessary, and whether alternative products would perform just as well.
- Environmentally Preferable Purchasing Program to minimize the purchase of products containing hazardous ingredients used in the facility's custodial services, fleet maintenance, and facility maintenance in favor of using alternate products that pose less risk to employees and to the environment.
- Integrated Pest Management (IPM) or Less-Toxic Pesticide Program, which uses a pest management approach that minimizes the use of toxic chemicals and gets rid of pests

## Objectives

- Educate
- Reduce/Minimize
- Product Substitution

## Targeted Constituents

Sediment	
Nutrients	✓
Trash	
Metals	✓
Bacteria	
Oil and Grease	✓
Organics	✓

## Minimum BMPs Covered

 Good Housekeeping	
 Preventative Maintenance	
 Spill and Leak Prevention and Response	
 Material Handling & Waste Management	
 Erosion and Sediment Controls	
 Employee Training Program	✓
 Quality Assurance Record Keeping	



by methods that pose a lower risk to employees, the public, and the environment.

- Energy Efficiency Program including no-cost and low-cost energy conservation and efficiency actions that can reduce both energy consumption and electricity bills, along with long-term energy efficiency investments.

Consider the following mechanisms for developing and implementing a comprehensive program:

- Policies
- Procedures
  - ✓ Standard operating procedures (SOPs);
  - ✓ Purchasing guidelines and procedures; and
  - ✓ Bid packages (services and supplies).
- Materials
  - ✓ Preferred or approved product and supplier lists;
  - ✓ Product and supplier evaluation criteria;
  - ✓ Training sessions and manuals; and
  - ✓ Fact sheets for employees.

Implement this BMP in conjunction with the Vehicle and Equipment Management fact sheets (SC-20 – SC-22) and SC-41 Building and Grounds Maintenance.



### ***Employee Training Program***

- Employees who handle potentially harmful materials should be trained in the use of safer alternatives.
- Purchasing departments should be trained on safer alternative products and encouraged to procure less hazardous materials and products that contain little or no harmful substances or TMDL pollutants.
- Employees and contractors / service providers can both be educated about safer alternatives by using information developed by a number of organizations including the references and resources provided in this fact sheet.

### **Potential Limitations and Work-Arounds**

Some facilities may have space constraints, limited staffing and time limitations that may preclude implementation of BMPs. Provided below are typical limitations and recommended “work-arounds”

- Alternative products may not be available, suitable, or effective in every case.

- ✓ Minimize use of hazardous/harmful products if no alternative product is available.

## Regulatory Considerations

This BMP has no regulatory requirements unless local/municipal ordinance applies. Existing regulations already encourage facilities to reduce the use of hazardous materials through incentives such as reduced:

- Specialized equipment storage and handling requirements;
- Storm water runoff sampling requirements;
- Training and licensing requirements; and
- Record keeping and reporting requirements.

## Cost Considerations

- The primary cost is for staff time to: 1) develop new policies and procedures and 2) educate purchasing departments and employees who handle potentially harmful materials about the availability, procurement, and use of safer alternatives.
- Some alternative products may be slightly more expensive than conventional products.

## Supplemental Information

The following discussion provides some general information on safer alternatives. More specific information on particular hazardous materials and the available alternatives may be found in the references and resources listed below.

- Automotive products – Less toxic alternatives are not available for many automotive products, especially engine fluids. But there are alternatives to grease lubricants, car polishes, degreasers, and windshield washer solution. Refined motor oil is also available.
- Vehicle/Trailer lubrication – Fifth wheel bearings on trucks require routine lubrication. Adhesive lubricants are available to replace typical chassis grease.
- Cleaners – Vegetables-based or citrus-based soaps are available to replace petroleum-based soaps/detergents.
- Paint products – Water-based paints, wood preservatives, stains, and finishes with low VOC content are available.
- Pesticides – Specific alternative products or methods exist to control most insects, fungi, and weeds.
- Chemical Fertilizers – Compost and soil amendments are natural alternatives.
- Consumables – Manufacturers have either reduced or are in the process of reducing the amount of heavy metals in consumables such as batteries and fluorescent lamps.

All fluorescent lamps contain mercury, however low-mercury containing lamps are now available from most hardware and lighting stores. Fluorescent lamps are also more energy efficient than the average incandescent lamp.

- Janitorial chemicals – Even biodegradable soap can harm fish and wildlife before it biodegrades. Biodegradable does not mean non-toxic. Safer products and procedures are available for floor stripping and cleaning, as well as carpet, glass, metal, and restroom cleaning and disinfecting. Use paper products with post-consumer recycled content and implement electric had dryers.

### ***Examples***

There are a number of business and trade associations, and communities with effective programs. Some of the more prominent are listed below in the references and resources section.

### **References and Resources**

Note: Many of these references provide alternative products for materials that typically are used inside and disposed to the sanitary sewer as well as alternatives to products that usually end up in the storm drain.

#### ***General Sustainable Practices and Pollution Prevention Including Pollutant-Specific Information***

California Department of Toxic Substances Control,  
<http://www.dtsc.ca.gov/PollutionPrevention/GreenTechnology/Index.cfm>.

CalRecycle, <http://www.calrecycle.ca.gov/Business/Regulated.htm>.

City of Santa Monica Office of Sustainability and Environment,  
<http://www.smgov.net/departments/ose/>.

City of Palo Alto, <http://www.city.palo-alto.ca.us/cleanbay>.

City and County of San Francisco, Department of the Environment,  
<http://www.sfenvironment.org/toxics-health/greener-business-practices>.

Green Business Program, <http://www.greenbiz.ca.gov/GRlocal.html> .

Product Stewardship Institute, <http://www.productstewardship.us/index.cfm>.

Sacramento Clean Water Business Partners.  
<http://www.sacstormwater.org/CleanWaterBusinessPartners/CleanWaterBusinessPartners.html>.

USEPA. National Pollutant Discharge Elimination System (NPDES) Stormwater Discharges From Industrial Facilities,  
<http://cfpub.epa.gov/npdes/stormwater/indust.cfm>.

USEPA Region IX Pollution Prevention Program,  
<http://www.epa.gov/region9/waste/p2/business.html>.



Western Sustainability and Pollution Prevention Network, <http://wsppn.org/>.

### ***Metals (mercury, copper)***

National Electrical Manufacturers Association – Environmental Stewardship,  
<http://www.nema.org/Policy/Environmental-Stewardship/pages/default.aspx>.

Sustainable Conservation, <http://www.suscon.org>.

Auto Recycling Project

Brake Pad Partnership

### ***Pesticides and Chemical Fertilizers***

Bio-Integral Resource Center, <http://www.birc.org>.

California Department of Pesticide Regulation,  
<http://www.cdpr.ca.gov/dprprograms.htm>.

University of California Statewide IPM Program,  
<http://www.ipm.ucdavis.edu/default.html>.

### ***Dioxins***

Bay Area Dioxins Project,  
[http://www.abag.ca.gov/bayarea/dioxin/project\\_materials.htm](http://www.abag.ca.gov/bayarea/dioxin/project_materials.htm).

# Building & Grounds Maintenance SC-41

## Description

Stormwater runoff from building and grounds maintenance activities can be contaminated with toxic hydrocarbons in solvents, fertilizers and pesticides, suspended solids, heavy metals, abnormal pH, and oils and greases. Utilizing the protocols in this fact sheet will prevent or reduce the discharge of pollutants to stormwater from building and grounds maintenance activities by washing and cleaning up with as little water as possible, following good landscape management practices, preventing and cleaning up spills immediately, keeping debris from entering the storm drains, and maintaining the stormwater collection system.

## Approach

Reduce potential for pollutant discharge through source control pollution prevention and BMP implementation. Successful implementation depends on effective training of employees on applicable BMPs and general pollution prevention strategies and objectives.

## General Pollution Prevention Protocols

- Switch to non-toxic chemicals for maintenance to the maximum extent possible.
- Choose cleaning agents that can be recycled.
- Encourage proper lawn management and landscaping, including use of native vegetation.
- Encourage use of Integrated Pest Management techniques for pest control.
- Encourage proper onsite recycling of yard trimmings.
- Recycle residual paints, solvents, lumber, and other material as much as possible.

## Objectives

- Cover
- Contain
- Educate
- Reduce/Minimize
- Product Substitution

## Targeted Constituents

Sediment	✓
Nutrients	✓
Trash	
Metals	✓
Bacteria	✓
Oil and Grease	
Organics	

## Minimum BMPs Covered

 Good Housekeeping	✓
 Preventative Maintenance	
 Spill and Leak Prevention and Response	✓
 Material Handling & Waste Management	✓
 Erosion and Sediment Controls	
 Employee Training Program	✓
 Quality Assurance Record Keeping	✓



# Building & Grounds Maintenance SC-41

---

- Clean work areas at the end of each work shift using dry cleaning methods such as sweeping and vacuuming.



## **Good Housekeeping**

### *Pressure Washing of Buildings, Rooftops, and Other Large Objects*

- In situations where soaps or detergents are used and the surrounding area is paved, pressure washers must use a water collection device that enables collection of wash water and associated solids. A sump pump, wet vacuum or similarly effective device must be used to collect the runoff and loose materials. The collected runoff and solids must be disposed of properly.
- If soaps or detergents are not used, and the surrounding area is paved, wash runoff does not have to be collected but must be screened. Pressure washers must use filter fabric or some other type of screen on the ground and/or in the catch basin to trap the particles in wash water runoff.
- If you are pressure washing on a grassed area (with or without soap), runoff must be dispersed as sheet flow as much as possible, rather than as a concentrated stream. The wash runoff must remain on the grass and not drain to pavement.

### *Landscaping Activities*

- Dispose of grass clippings, leaves, sticks, or other collected vegetation as garbage, or by composting. Do not dispose of collected vegetation into waterways or storm drainage systems.
- Use mulch or other erosion control measures on exposed soils. See also SC-40, Contaminated and Erodible Areas, for more information.

### *Building Repair, Remodeling, and Construction*

- Do not dump any toxic substance or liquid waste on the pavement, the ground, or toward a storm drain.
- Use ground or drop cloths underneath outdoor painting, scraping, and sandblasting work, and properly dispose of collected material daily.
- Use a ground cloth or oversized tub for activities such as paint mixing and tool cleaning.
- Clean paintbrushes and tools covered with water-based paints in sinks connected to sanitary sewers or in portable containers that can be dumped into a sanitary sewer drain. Brushes and tools covered with non-water-based paints, finishes, or other materials must be cleaned in a manner that enables collection of used solvents (e.g., paint thinner, turpentine, etc.) for recycling or proper disposal.
- Use a storm drain cover, filter fabric, or similarly effective runoff control mechanism if dust, grit, wash water, or other pollutants may escape the work area and enter a catch basin. This is particularly necessary on rainy days. The containment device(s) must be in place at the beginning of the work day, and accumulated dirty runoff and

# **Building & Grounds Maintenance SC-41**

---

solids must be collected and disposed of before removing the containment device(s) at the end of the work day.

- If you need to de-water an excavation site, you may need to filter the water before discharging to a catch basin or off-site. If directed off-site, you should direct the water through hay bales and filter fabric or use other sediment filters or traps.
- Store toxic material under cover during precipitation events and when not in use. A cover would include tarps or other temporary cover material.

## *Mowing, Trimming, and Planting*

- Dispose of leaves, sticks, or other collected vegetation as garbage, by composting or at a permitted landfill. Do not dispose of collected vegetation into waterways or storm drainage systems.
- Use mulch or other erosion control measures when soils are exposed.
- Place temporarily stockpiled material away from watercourses and drain inlets, and berm or cover stockpiles to prevent material releases to the storm drain system.
- Consider an alternative approach when bailing out muddy water: do not put it in the storm drain; pour over landscaped areas.
- Use hand weeding where practical.

## *Fertilizer and Pesticide Management*

- Do not use pesticides if rain is expected.
- Do not mix or prepare pesticides for application near storm drains.
- Use the minimum amount needed for the job.
- Calibrate fertilizer distributors to avoid excessive application.
- Employ techniques to minimize off-target application (e.g., spray drift) of pesticides, including consideration of alternative application techniques.
- Apply pesticides only when wind speeds are low.
- Fertilizers should be worked into the soil rather than dumped or broadcast onto the surface.
- Irrigate slowly to prevent runoff and then only as much as is needed.
- Clean pavement and sidewalk if fertilizer is spilled on these surfaces before applying irrigation water.

## *Inspection*

- Inspect irrigation system periodically to ensure that the right amount of water is being applied and that excessive runoff is not occurring. Minimize excess watering and repair leaks in the irrigation system as soon as they are observed.

# Building & Grounds Maintenance SC-41

---



## ***Spill Response and Prevention Procedures***

- Keep your Spill Prevention Control and Countermeasure (SPCC) Plan up-to-date.
- Place a stockpile of spill cleanup materials, such as brooms, dustpans, and vacuum sweepers (if desired) near the storage area where it will be readily accessible.
- Have employees trained in spill containment and cleanup present during the loading/unloading of dangerous wastes, liquid chemicals, or other materials.
- Familiarize employees with the Spill Prevention Control and Countermeasure Plan.
- Clean up spills immediately.



## ***Material Handling and Waste Management***

- Follow all federal, state, and local laws and regulations governing the use, storage, and disposal of fertilizers and pesticides and training of applicators and pest control advisors.
- Use less toxic pesticides that will do the job when applicable. Avoid use of copper-based pesticides if possible.
- Dispose of empty pesticide containers according to the instructions on the container label.
- Use up the pesticides. Rinse containers, and use rinse water as product. Dispose of unused pesticide as hazardous waste.
- Implement storage requirements for pesticide products with guidance from the local fire department and County Agricultural Commissioner. Provide secondary containment for pesticides.



## ***Employee Training Program***

- Educate and train employees on pesticide use and in pesticide application techniques to prevent pollution.
- Train employees and contractors in proper techniques for spill containment and cleanup.
- Be sure the frequency of training takes into account the complexity of the operations and the needs of individual staff.



## ***Quality Assurance and Record Keeping***

- Keep accurate logs that document maintenance activities performed and minimum BMP measures implemented.
- Keep accurate logs of spill response actions that document what was spilled, how it was cleaned up, and how the waste was disposed.
- Establish procedures to complete logs and file them in the central office.

# **Building & Grounds Maintenance SC-41**

---

## **Potential Capital Facility Costs and Operation & Maintenance Requirements**

### ***Facilities***

- Additional capital costs are not anticipated for building and grounds maintenance. Implementation of the minimum BMPs described above should be conducted as part of regular site operations.

### ***Maintenance***

- Maintenance activities for the BMPs described above will be minimal, and no additional cost is anticipated.

## **Supplemental Information**

### ***Fire Sprinkler Line Flushing***

Site fire sprinkler line flushing may be a source of non-stormwater runoff pollution. The water entering the system is usually potable water, though in some areas it may be non-potable reclaimed wastewater. There are subsequent factors that may drastically reduce the quality of the water in such systems. Black iron pipe is usually used since it is cheaper than potable piping, but it is subject to rusting and results in lower quality water. Initially, the black iron pipe has an oil coating to protect it from rusting between manufacture and installation; this will contaminate the water from the first flush but not from subsequent flushes. Nitrates, poly-phosphates and other corrosion inhibitors, as well as fire suppressants and antifreeze may be added to the sprinkler water system. Water generally remains in the sprinkler system a long time (typically a year) and between flushes may accumulate iron, manganese, lead, copper, nickel, and zinc. The water generally becomes anoxic and contains living and dead bacteria and breakdown products from chlorination. This may result in a significant BOD problem and the water often smells. Consequently dispose fire sprinkler line flush water into the sanitary sewer. Do not allow discharge to storm drain or infiltration due to potential high levels of pollutants in fire sprinkler line water.

## **References and Resources**

City of Seattle, Seattle Public Utilities Department of Planning and Development, 2009. *Stormwater Manual Vol. 1 Source Control Technical Requirements Manual*.

Kennedy/Jenks Consultants, 2007. *The Truckee Meadows Industrial and Commercial Storm Water Best Management Practices Handbook*. Available online at: [http://www.cityofsparks.us/sites/default/files/assets/documents/env-control/construction/TM-I-C\\_BMP\\_Handbook\\_2-07-final.pdf](http://www.cityofsparks.us/sites/default/files/assets/documents/env-control/construction/TM-I-C_BMP_Handbook_2-07-final.pdf).

Orange County Stormwater Program, Best Management Practices for Industrial/Commercial Business Activities. Available online at: <http://ocwatersheds.com/documents/bmp/industrialcommercialbusinessesactivities>.

Sacramento Stormwater Management Program. *Best Management Practices for Industrial Storm Water Pollution Control*. Available online at:

# **Building & Grounds Maintenance SC-41**

<http://www.msa.saccounty.net/sactostormwater/documents/guides/industrial-BMP-manual.pdf>.

US EPA, 1997. *Best Management Practices Handbook for Hazardous Waste Containers*. Available online at: <http://www.epa.gov/region6/6en/h/handbk4.pdf>.

Ventura Countywide Stormwater Management Program Clean Business Fact Sheets. Available online at: [http://www.vcstormwater.org/documents/programs\\_business/building.pdf](http://www.vcstormwater.org/documents/programs_business/building.pdf).

# Building Repair and Construction SC-42

## Description

Site modifications are common, particularly at large industrial sites. The activity may vary from minor and normal building repair to major remodeling, or the construction of new facilities. These activities can generate pollutants including solvents, paints, paint and varnish removers, finishing residues, spent thinners, soap cleaners, kerosene, asphalt and concrete materials, adhesive residues, and old asbestos installation. Protocols in this fact sheet are intended to prevent or reduce the discharge of pollutants to stormwater from building repair, remodeling, and minor construction by using soil erosion controls, enclosing or covering building material storage areas, using good housekeeping practices, using safer alternative products, and training employees.

This fact sheet is intended to be used for minor repairs and construction. If major construction is required, the guidelines in the Construction BMP Handbook should be followed.

## Approach

The BMP approach is to reduce potential for pollutant discharges through source control pollution prevention and BMP implementation. Successful implementation depends on effective training of employees on applicable BMPs and general pollution prevention strategies and objectives.

### General Pollution Prevention Protocols

- Recycle residual paints, solvents, lumber, and other materials to the maximum extent practicable.
- Avoid outdoor repairs and construction during periods of wet weather.
- Use safer alternative products to the maximum extent practicable. See also SC-35 Safer Alternative Products for more information.

## Objectives

- Cover
- Contain
- Educate
- Reduce/Minimize
- Product Substitution

## Targeted Constituents

Sediment	✓
Nutrients	
Trash	✓
Metals	✓
Bacteria	
Oil and Grease	✓
Organics	✓

## Minimum BMPs Covered

	Good Housekeeping	✓
	Preventative Maintenance	
	Spill and Leak Prevention and Response	✓
	Material Handling & Waste Management	✓
	Erosion and Sediment Controls	✓
	Employee Training Program	✓
	Quality Assurance Record Keeping	✓



CALIFORNIA STORMWATER  
QUALITY ASSOCIATION®



# Building Repair and Construction SC-42

---

- Buy recycled products to the maximum extent practicable.
- Inform on-site contractors of company policy on these matters and include appropriate provisions in their contract to ensure certain proper housekeeping and disposal practices are implemented.
- Make sure that nearby storm drains are well marked to minimize the chance of inadvertent disposal of residual paints and other liquids.



## **Good Housekeeping**

### *Repair & Remodeling*

- Keep the work site clean and orderly. Remove debris in a timely fashion. Sweep and vacuum the area regularly to remove sediments and small debris.
- Cover raw materials of particular concern that must be left outside, particularly during the rainy season. See also SC-33 Outdoor Storage of Raw Materials for more information.
- Use equipment and tools such as bag sanders to reduce accumulation of debris.
- Limit/prohibit work on windy days; implement roll-down walls or other measures to reduce wind transport of pollutants.
- Do not dump waste liquids down the storm drain.
- Dispose of wash water, sweepings, and sediments properly.
- Store liquid materials properly that are normally used in repair and remodeling such as paints and solvents. See also SC-31 Outdoor Liquid Container Storage for more information.
- Sweep out rain gutters or wash the gutter and trap the particles at the outlet of the downspout. A sock or geofabric placed over the outlet may effectively trap the materials. If the downspout is tight lined, place a temporary plug at the first convenient point in the storm drain and pump out the water with a vactor truck, and clean the catch basin sump where you placed the plug.
- Clean the storm drain system in the immediate vicinity of the construction activity after it is completed. See also SC-44 Drainage System Maintenance for more information.

### *Painting*

- Enclose painting operations consistent with local air quality regulations and OSHA.
- Local air pollution regulations may, in many areas of the state, specify painting procedures which if properly carried out are usually sufficient to protect water quality.
- Develop paint handling procedures for proper use, storage, and disposal of paints.

# Building Repair and Construction SC-42

---

- Transport paint and materials to and from job sites in containers with secure lids and tied down to the transport vehicle.
- Test and inspect spray equipment prior to starting to paint. Tighten all hoses and connections and do not overfill paint containers.
- Mix paint indoors before using so that any spill will not be exposed to rain. Do so even during dry weather because cleanup of a spill will never be 100 percent effective.
- Transfer and load paint and hot thermoplastic away from storm drain inlets.
- Do not transfer or load paint near storm drain inlets.
- Plug nearby storm drain inlets prior to starting painting and remove plugs when job is complete when there is risk of a spill reaching storm drains.
- Cover nearby storm drain inlets prior to starting work if sand blasting is used to remove paint.
- Use a ground cloth to collect the chips if painting requires scraping or sand blasting of the existing surface. Dispose of the residue properly.
- Cover or enclose painting operations properly to avoid drift.
- Clean the application equipment in a sink that is connected to the sanitary sewer if using water based paints.
- Capture all cleanup-water and dispose of properly.
- Dispose of paints containing lead or tributyl tin and considered a hazardous waste properly.
- Store leftover paints if they are to be kept for the next job properly, or dispose properly.
- Recycle paint when possible. Dispose of paint at an appropriate household hazardous waste facility.



## ***Spill Response and Prevention Procedures***

- Keep your spill prevention and control plan up-to-date.
- Place a stockpile of spill cleanup materials where it will be readily accessible.
- Clean up spills immediately.
- Excavate and remove the contaminated (stained) soil if a spill occurs on dirt.



## ***Material Handling and Waste Management***

- Post “No Littering” signs and enforce anti-litter laws.

# **Building Repair and Construction SC-42**

---

- Provide a sufficient number of litter receptacles for the facility.
- Clean out and cover litter receptacles frequently to prevent spillage.
- Keep waste collection areas clean.
- Inspect solid waste containers for structural damage regularly. Repair or replace damaged containers as necessary.
- Secure solid waste containers; containers must be closed tightly when not in use.
- Do not fill waste containers with washout water or any other liquid.
- Ensure that only appropriate solid wastes are added to the solid waste container. Certain wastes such as hazardous wastes, appliances, fluorescent lamps, pesticides, etc., may not be disposed of in solid waste containers (see chemical/ hazardous waste collection section below).
- Do not mix wastes; this can cause chemical reactions, make recycling impossible, and complicate disposal. Affix labels to all waste containers.
- Make sure that hazardous waste is collected, removed, and disposed of properly. See also SC-34, Waste Handling and Disposal for more information.



## ***Sediment and Erosion Controls***

- Limit disturbance to bare soils and preserve natural vegetation whenever possible. See also EC-2, Preservation of Existing Vegetation, in the Construction BMP Handbook.
- Stabilize loose soils by re-vegetating whenever possible. See also EC-4 Hydroseeding, in the Construction BMP Handbook.
- Utilize non-vegetative stabilization methods for areas prone to erosion where vegetative options are not feasible. Examples include:
  - ✓ Areas of vehicular or pedestrian traffic such as roads or paths;
  - ✓ Arid environments where vegetation would not provide timely ground coverage, or would require excessive irrigation;
  - ✓ Rocky substrate, infertile or droughty soils where vegetation would be difficult to establish; and
  - ✓ Areas where vegetation will not grow adequately within the construction time frame.

There are several non-vegetative stabilization methods and selection should be based on site-specific conditions. See also EC-16 Non-Vegetative Stabilization, in the Construction BMP Handbook.

# Building Repair and Construction SC-42

---

- Utilize chemical stabilization when needed. See also EC-5 Soil Binders, in the Construction BMP Handbook.
- Use geosynthetic membranes to control erosion if feasible. See also EC-7 Geotextiles and Mats, in the Construction BMP Handbook.
- Stabilize all roadways, entrances, and exits to sufficiently control discharges of erodible materials from discharging or being tracked off the site. See also TC 1-3 Tracking Control, in the Construction BMP Handbook.
- Refer to the supplemental information provided below for projects that involve more extensive soil disturbance activities.



## ***Employee Training Program***

- Educate employees about pollution prevention measures and goals.
- Train employees how to properly implement the source control BMPs described above. Detailed information for Sediment and Erosion Control BMPs is provided in the Construction BMP Handbook.
- Proper education of off-site contractors is often overlooked. The conscientious efforts of well trained employees can be lost by unknowing off-site contractors, so make sure they are well informed about pollutant source control responsibilities.
- Use a training log or similar method to document training.



## ***Quality Assurance and Record Keeping***

- Keep accurate maintenance logs that document minimum BMP activities performed for building repair and construction, types and quantities of waste disposed of, and any improvement actions.
- Keep accurate logs of spill response actions that document what was spilled, how it was cleaned up, and how the waste was disposed.
- Establish procedures to complete logs and file them in the central office.

## **Potential Limitations and Work-Arounds**

Some facilities may have space constraints, limited staffing and time limitations that may preclude implementation of BMPs. Provided below are typical limitations and recommended “work-arounds.”

- This BMP is for minor construction only. The State’s General Construction Activity Stormwater Permit has more extensive requirements for larger projects that would disturb one or more acres of surface.
  - ✓ Refer to the companion “Construction Best Management Practice Handbook” which contains specific guidance and best management practices for larger-scale projects.

# Building Repair and Construction SC-42

---

- Time constraints may require some outdoor repairs and construction during wet weather.
  - ✓ Require employees to understand and follow good housekeeping and spill and leak prevention BMPs.
  - ✓ Inspect sediment and erosion control BMPs daily during periods of wet weather and repair or improve BMP implementation as necessary.
- Hazardous waste that cannot be reused or recycled must be disposed of by a licensed hazardous waste hauler.
  - ✓ Minimize use of hazardous materials to the maximum extent practicable.
- Be certain that actions to help stormwater quality are consistent with Cal- and Fed-OSHA and air quality regulations.
- Prices for recycled/safer alternative materials and fluids may be higher than those of conventional materials.

## Potential Capital Facility Costs and Operation & Maintenance Requirements

### *Facilities*

- Limited capital investments may be required at some sites if adequate cover and containment facilities do not exist for construction materials and wastes.
- Purchase and installation of erosion and sediment controls, if needed will require additional capital investments, and this amount will vary depending on site characteristics and the types of BMPs being implemented.
- Minimize costs by maintaining existing vegetation and limiting construction operations on bare soils.

### *Maintenance*

- The erosion and sediment control BMPs described above require periodic inspection and maintenance to remain effective. The cost of these actions will vary depending on site characteristics and the types of BMPs being implemented.
- Irrigation costs may be required to establish and maintain vegetation.

## Supplemental Information

### *Soil/Erosion Control*

If the work involves exposing large areas of soil, employ the appropriate soil erosion and control techniques. See the Construction Best Management Practice Handbook. If old buildings are being torn down and not replaced in the near future, stabilize the site using measures described in SC-40 Contaminated or Erodible Areas.

# **Building Repair and Construction SC-42**

---

If a building is to be placed over an open area with a storm drainage system, make sure the storm inlets within the building are covered or removed, or the storm line is connected to the sanitary sewer. If because of the remodeling a new drainage system is to be installed or the existing system is to be modified, consider installing catch basins as they serve as effective “in-line” treatment devices. Include in the catch basin a “turn-down” elbow or similar device to trap floatables.

## **References and Resources**

City of Seattle, Seattle Public Utilities Department of Planning and Development, 2009. *Stormwater Manual Vol. 1 Source Control Technical Requirements Manual*.

California Stormwater Quality Association, 2012. *Construction Stormwater Best Management Practice Handbook*. Available at <http://www.casqa.org>.

Kennedy/Jenks Consultants, 2007. *The Truckee Meadows Industrial and Commercial Storm Water Best Management Practices Handbook*. Available online at: [http://www.cityofsparks.us/sites/default/files/assets/documents/env-control/construction/TM-I-C\\_BMP\\_Handbook\\_2-07-final.pdf](http://www.cityofsparks.us/sites/default/files/assets/documents/env-control/construction/TM-I-C_BMP_Handbook_2-07-final.pdf).

Sacramento Stormwater Management Program. *Best Management Practices for Industrial Storm Water Pollution Control*. Available online at: <http://www.msa.saccounty.net/sactostormwater/documents/guides/industrial-BMP-manual.pdf>.

US EPA. *Construction Site Stormwater Runoff Control*. Available online at: [http://cfpub.epa.gov/npdes/stormwater/menuofbmps/index.cfm?action=min\\_measure&min\\_measure\\_id=4](http://cfpub.epa.gov/npdes/stormwater/menuofbmps/index.cfm?action=min_measure&min_measure_id=4).

## Description

Parking lots can contribute a number of substances, such as trash, suspended solids, hydrocarbons, oil and grease, and heavy metals that can enter receiving waters through stormwater runoff or non-stormwater discharges. The protocols in this fact sheet are intended to prevent or reduce the discharge of pollutants from parking areas and include using good housekeeping practices, following appropriate cleaning BMPs, and training employees.

BMPs for other outdoor areas on site (loading/unloading, material storage, and equipment operations) are described in SC-30 through SC-33.

## Approach

The goal of this program is to ensure stormwater pollution prevention practices are considered when conducting activities on or around parking areas to reduce potential for pollutant discharge to receiving waters. Successful implementation depends on effective training of employees on applicable BMPs and general pollution prevention strategies and objectives.

### General Pollution Prevention Protocols

- Encourage advanced designs and maintenance strategies for impervious parking lots. Refer to the treatment control BMP fact sheets in this manual for additional information.
- Keep accurate maintenance logs to evaluate BMP implementation.



### Good Housekeeping

- Keep all parking areas clean and orderly. Remove debris, litter, and sediments in a timely fashion.
- Post “No Littering” signs and enforce anti-litter laws.

## Objectives

- Cover
- Contain
- Educate
- Reduce/Minimize
- Product Substitution

## Targeted Constituents

Sediment	✓
Nutrients	
Trash	✓
Metals	✓
Bacteria	
Oil and Grease	✓
Organics	✓

## Minimum BMPs Covered

	Good Housekeeping	✓
	Preventative Maintenance	✓
	Spill and Leak Prevention and Response	✓
	Material Handling & Waste Management	
	Erosion and Sediment Controls	
	Employee Training Program	✓
	Quality Assurance Record Keeping	✓



CALIFORNIA STORMWATER  
QUALITY ASSOCIATION®

- Provide an adequate number of litter receptacles.
- Clean out and cover litter receptacles frequently to prevent spillage.



## ***Preventative Maintenance***

### *Inspection*

Have designated personnel conduct inspections of parking facilities and stormwater conveyance systems associated with parking facilities on a regular basis.

- Inspect cleaning equipment/sweepers for leaks on a regular basis.

### *Surface Cleaning*

- Use dry cleaning methods (e.g., sweeping, vacuuming) to prevent the discharge of pollutants into the stormwater conveyance system if possible.
- Establish frequency of public parking lot sweeping based on usage and field observations of waste accumulation.
- Sweep all parking lots at least once before the onset of the wet season.
- Dispose of parking lot sweeping debris and dirt at a landfill.
- Follow the procedures below if water is used to clean surfaces:
  - ✓ Block the storm drain or contain runoff.
  - ✓ Collect and pump wash water to the sanitary sewer or discharge to a pervious surface. Do not allow wash water to enter storm drains.
- Follow the procedures below when cleaning heavy oily deposits:
  - ✓ Clean oily spots with absorbent materials.
  - ✓ Use a screen or filter fabric over inlet, then wash surfaces.
  - ✓ Do not allow discharges to the storm drain.
  - ✓ Vacuum/pump discharges to a tank or discharge to sanitary sewer.
  - ✓ Dispose of spilled materials and absorbents appropriately.

### *Surface Repair*

- Check local ordinance for SUSMP/LID ordinance.
- Preheat, transfer or load hot bituminous material away from storm drain inlets.
- Apply concrete, asphalt, and seal coat during dry weather to prevent contamination from contacting stormwater runoff.
- Cover and seal nearby storm drain inlets where applicable (with waterproof material or mesh) and manholes before applying seal coat, slurry seal, etc. Leave covers in



place until job is complete and all water from emulsified oil sealants has drained or evaporated. Clean any debris from these covered manholes and drains for proper disposal.

- Use only as much water as necessary for dust control during sweeping to avoid runoff.
- Catch drips from paving equipment that is not in use with pans or absorbent material placed under the machines. Dispose of collected material and absorbents properly.



## ***Spill Response and Prevention Procedures***

- Keep your Spill Prevention Control and Countermeasure (SPCC) Plan up-to-date.
- Place a stockpile of spill cleanup materials where it will be readily accessible or at a central location.
- Clean up fluid spills immediately with absorbent rags or material.
- Dispose of spilled material and absorbents properly.



## ***Employee Training Program***

- Provide regular training to field employees and/or contractors regarding cleaning of paved areas and proper operation of equipment.
- Train employees and contractors in proper techniques for spill containment and cleanup.
- Use a training log or similar method to document training.



## ***Quality Assurance and Record Keeping***

- Keep accurate maintenance logs that document minimum BMP activities performed for parking area maintenance, types and quantities of waste disposed of, and any improvement actions.
- Keep accurate logs of spill response actions that document what was spilled, how it was cleaned up, and how the waste was disposed.
- Establish procedures to complete logs and file them in the central office.

## **Potential Capital Facility Costs and Operation & Maintenance Requirements**

### ***Facilities***

- Capital investments may be required at some sites to purchase sweeping equipment, train sweeper operators, install oil/water/sand separators, or implement advanced BMPs. These costs can vary significantly depending upon site conditions and the amount of BMPs required.

## ***Maintenance***

- Sweep and clean parking lots regularly to minimize pollutant transport into storm drains from stormwater runoff.
- Clean out oil/water/sand separators regularly, especially after heavy storms.
- Maintain advanced BMPs such as vegetated swales, infiltration trenches, or detention basins as appropriate. Refer to the treatment control fact sheets for more information.

## **Supplemental Information**

### ***Advanced BMPs***

Some parking areas may require advanced BMPs to further reduce pollutants in stormwater runoff, and a few examples are listed below. Refer to the Treatment Control Fact Sheets and the New Development and Redevelopment Manual for more information.

- When possible, direct sheet runoff to flow into biofilters (vegetated strip and swale) and/or infiltration devices.
- Utilize sand filters or oleophilic collectors for oily waste in low quantities.
- Arrange rooftop drains to prevent drainage directly onto paved surfaces.
- Design lot to include semi-permeable hardscape.

## **References and Resources**

City of Seattle, Seattle Public Utilities Department of Planning and Development, 2009. *Stormwater Manual Vol. 1 Source Control Technical Requirements Manual*.

California Stormwater Quality Association, 2003. *New Development and Redevelopment Stormwater Best Management Practice Handbook*. Available online at: <https://www.casqa.org/resources/bmp-handbooks/new-development-redevelopment-bmp-handbook>.

Kennedy/Jenks Consultants, 2007. *The Truckee Meadows Industrial and Commercial Storm Water Best Management Practices Handbook*. Available online at: [http://www.cityofsparks.us/sites/default/files/assets/documents/env-control/construction/TM-I-C BMP Handbook 2-07-final.pdf](http://www.cityofsparks.us/sites/default/files/assets/documents/env-control/construction/TM-I-C_BMP_Handbook_2-07-final.pdf).

Orange County Stormwater Program, Best Management Practices for Industrial/Commercial Business Activities. Available online at: <http://ocwatersheds.com/documents/bmp/industrialcommercialbusinessactivities>.

Pollution from Surface Cleaning Folder, 1996, 2003. Bay Area Stormwater Management Agencies Association. Available online at:

<http://basmaa.org/Portals/0/documents/pdf/Pollution%20from%20Surface%20Cleaning.pdf>.

Sacramento Stormwater Management Program. *Best Management Practices for Industrial Storm Water Pollution Control*. Available online at:

<http://www.msa.saccounty.net/sactostormwater/documents/guides/industrial-BMP-manual.pdf>.

The Storm Water Managers Resource Center, <http://www.stormwatercenter.net>.

US EPA. *Post-Construction Stormwater Management in New Development and Redevelopment*. BMP Fact Sheets. Available online at:

[http://cfpub.epa.gov/npdes/stormwater/menuofbmps/index.cfm?action=min\\_measure&min\\_measure\\_id=5](http://cfpub.epa.gov/npdes/stormwater/menuofbmps/index.cfm?action=min_measure&min_measure_id=5).

# Drainage System Maintenance SC-44

## Description

As a consequence of its function, the stormwater drainage facilities on site convey stormwater that may contain certain pollutants either to the offsite conveyance system that collects and transports urban runoff and stormwater, or directly to receiving waters. The protocols in this fact sheet are intended to reduce pollutants leaving the site to the offsite drainage infrastructure or to receiving waters through proper on-site conveyance system operation and maintenance. The targeted constituents will vary depending on site characteristics and operations.

## Approach

Successful implementation depends on effective training of employees on applicable BMPs and general pollution prevention strategies and objectives.

### General Pollution Prevention Protocols

- Maintain catch basins, stormwater inlets, and other stormwater conveyance structures on a regular basis to remove pollutants, reduce high pollutant concentrations during the first flush of storms, prevent clogging of the downstream conveyance system, restore catch basins' sediment trapping capacity, and ensure the system functions properly hydraulically to avoid flooding.
- Develop and follow a site specific drainage system maintenance plan that describes maintenance locations, methods, required equipment, water sources, sediment collection areas, disposal requirements, and any other pertinent information.



### Good Housekeeping

#### Illicit Connections and Discharges

- Look for evidence of illegal discharges or illicit connections during routine maintenance of conveyance system and drainage structures:

## Objectives

- Cover
- Contain
- Educate
- Reduce/Minimize

## Targeted Constituents

Sediment	✓
Nutrients	✓
Trash	✓
Metals	✓
Bacteria	✓
Oil and Grease	✓
Organics	✓

## Minimum BMPs Covered

	Good Housekeeping	✓
	Preventative Maintenance	✓
	Spill and Leak Prevention and Response	✓
	Material Handling & Waste Management	
	Erosion and Sediment Controls	
	Employee Training Program	✓
	Quality Assurance Record Keeping	✓



CALIFORNIA STORMWATER QUALITY ASSOCIATION®

# Drainage System Maintenance **SC-44**

---

- ✓ Identify evidence of spills such as paints, discoloring, odors, etc.
- ✓ Record locations of apparent illegal discharges/illicit connections.
- ✓ Track flows back to potential discharges and conduct aboveground inspections. This can be done through visual inspection of upgradient manholes or alternate techniques including zinc chloride smoke testing, fluorometric dye testing, physical inspection testing, or television camera inspection.
- ✓ Eliminate the discharge once the origin of flow is established.
- Stencil or demarcate storm drains, where applicable, to prevent illegal disposal of pollutants. Storm drain inlets should have messages such as “Dump No Waste Drains to Stream” or similar stenciled next to them to warn against ignorant or intentional dumping of pollutants into the storm drainage system.
- Refer to fact sheet SC-10 Non-Stormwater Discharges for additional information.

## *Illegal Dumping*

- Inspect and clean up hot spots and other storm drainage areas regularly where illegal dumping and disposal occurs.
- Establish a system for tracking incidents. The system should be designed to identify the following:
  - ✓ Illegal dumping hot spots;
  - ✓ Types and quantities (in some cases) of wastes;
  - ✓ Patterns in time of occurrence (time of day/night, month, or year);
  - ✓ Mode of dumping (abandoned containers, “midnight dumping” from moving vehicles, direct dumping of materials, accidents/spills); and
  - ✓ Responsible parties.
- Post “No Dumping” signs in problem areas with a phone number for reporting dumping and disposal. Signs should also indicate fines and penalties for illegal dumping.
- Refer to fact sheet SC-10 Non-Stormwater Discharges for additional information.



## **Preventative Maintenance**

### *Catch Basins/Inlet Structures*

- Staff should regularly inspect facilities to ensure compliance with the following:
  - ✓ Immediate repair of any deterioration threatening structural integrity.
  - ✓ Cleaning before the sump is 40% full. Catch basins should be cleaned as frequently as needed to meet this standard.

# Drainage System Maintenance **SC-44**

---

- Clean catch basins, storm drain inlets, and other conveyance structures before the wet season to remove sediments and debris accumulated during the summer.
- Conduct inspections more frequently during the wet season for problem areas where sediment or trash accumulates more often. Prioritize storm drain inlets; clean and repair as needed.
- Keep accurate logs of the number of catch basins cleaned.
- Store wastes collected from cleaning activities of the drainage system in appropriate containers or temporary storage sites in a manner that prevents discharge to the storm drain.
- Dewater the wastes if necessary with outflow into the sanitary sewer if permitted. Water should be treated with an appropriate filtering device prior to discharge to the sanitary sewer. If discharge to the sanitary sewer is not allowed, water should be pumped or vacuumed to a tank and properly disposed. Do not dewater near a storm drain or stream.

## *Storm Drain Conveyance System*

- Locate reaches of storm drain with deposit problems and develop a flushing schedule that keeps the pipe clear of excessive buildup.
- Collect and pump flushed effluent to the sanitary sewer for treatment whenever possible.

## *Pump Stations*

- Clean all storm drain pump stations prior to the wet season to remove silt and trash.
- Do not allow discharge to reach the storm drain system when cleaning a storm drain pump station or other facility.
- Conduct routine maintenance at each pump station.
- Inspect, clean, and repair as necessary all outlet structures prior to the wet season.

## *Open Channel*

- Modify storm channel characteristics to improve channel hydraulics, increase pollutant removals, and enhance channel/creek aesthetic and habitat value.
- Conduct channel modification/improvement in accordance with existing laws. Any person, government agency, or public utility proposing an activity that will change the natural state of any river, stream, or lake in California, must enter into a Stream or Lake Alteration Agreement with the Department of Fish and Wildlife. The developer-applicant should also contact local governments (city, county, special districts), other state agencies (SWRCB, RWQCB, Department of Forestry, Department of Water Resources), and Army Corps of Engineers and USFWS.



## ***Spill Response and Prevention Procedures***

- Keep your spill prevention control plan up-to-date.

# Drainage System Maintenance **SC-44**

---

- Investigate all reports of spills, leaks, and/or illegal dumping promptly.
- Place a stockpile of spill cleanup materials where it will be readily accessible or at a central location.
- Clean up all spills and leaks using “dry” methods (with absorbent materials and/or rags) or dig up, remove, and properly dispose of contaminated soil.



## ***Employee Training Program***

- Educate employees about pollution prevention measures and goals.
- Train employees how to properly handle and dispose of waste using the source control BMPs described above.
- Train employees and subcontractors in proper hazardous waste management.
- Use a training log or similar method to document training.
- Ensure that employees are familiar with the site’s spill control plan and/or proper spill cleanup procedures.
- Have staff involved in detection and removal of illicit connections trained in the following:
  - ✓ OSHA-required Health and Safety Training (29 CFR 1910.120) plus annual refresher training (as needed).
  - ✓ OSHA Confined Space Entry training (Cal-OSHA Confined Space, Title 8 and Federal OSHA 29 CFR 1910.146).
  - ✓ Procedural training (field screening, sampling, smoke/dye testing, TV inspection).



## ***Quality Assurance and Record Keeping***

- Keep accurate maintenance logs that document minimum BMP activities performed for drainage system maintenance, types and quantities of waste disposed of, and any improvement actions.
- Keep accurate logs of spill response actions that document what was spilled, how it was cleaned up, and how the waste was disposed.
- Keep accurate logs of illicit connections, illicit discharges, and illegal dumping into the storm drain system including how wastes were cleaned up and disposed.
- Establish procedures to complete logs and file them in the central office.

## **Potential Limitations and Work-Arounds**

Provided below are typical limitations and recommended “work-arounds” for drainage system maintenance:

# Drainage System Maintenance SC-44

---

- Clean-up activities may create a slight disturbance for local aquatic species. Access to items and material on private property may be limited. Trade-offs may exist between channel hydraulics and water quality/riparian habitat. If storm channels or basins are recognized as wetlands, many activities, including maintenance, may be subject to regulation and permitting.
  - ✓ Perform all maintenance onsite and do not flush accumulated material downstream to private property or riparian habitats.
- Storm drain flushing is most effective in small diameter pipes (36-inch diameter pipe or less, depending on water supply and sediment collection capacity). Other considerations associated with storm drain flushing may include the availability of a water source, finding a downstream area to collect sediments, and liquid/sediment disposal.
  - ✓ Develop and follow a site specific drainage system maintenance plan that describes maintenance locations, methods, required equipment, water sources, sediment collection areas, disposal requirements, and any other pertinent information.
- Regulations may include adoption of substantial penalties for illegal dumping and disposal.
  - ✓ Do not dump illegal materials anywhere onsite.
  - ✓ Identify illicit connections, illicit discharge, and illegal dumping.
  - ✓ Cleanup spills immediately and properly dispose of wastes.
- Local municipal codes may include sections prohibiting discharge of soil, debris, refuse, hazardous wastes, and other pollutants into the sanitary sewer system.
  - ✓ Collect all materials and pollutants accumulated in drainage system and dispose of according to local regulations.
  - ✓ Install debris excluders in areas with a trash TMDL.

## Potential Capital Facility Costs and Operation & Maintenance Requirements

### *Facilities*

- Capital costs will vary substantially depending on the size of the facility and characteristics of the drainage system. Significant capital costs may be associated with purchasing water trucks, vacuum trucks, and any other necessary cleaning equipment or improving the drainage infrastructure to reduce the potential .
- Developing and implementing a site specific drainage system maintenance plan will require additional capital if a similar program is not already in place.



## *Maintenance*

- Two-person teams may be required to clean catch basins with vacuum trucks.
- Teams of at least two people plus administrative personnel are required to identify illicit discharges, depending on the complexity of the storm sewer system.
- Arrangements must be made for proper disposal of collected wastes.
- Technical staff are required to detect and investigate illegal dumping violations.
- Methods used for illicit connection detection (smoke testing, dye testing, visual inspection, and flow monitoring) can be costly and time-consuming. Site-specific factors, such as the level of impervious area, the density and ages of buildings, and type of land use will determine the level of investigation necessary.

## **Supplemental Information**

### *Storm Drain Flushing*

Flushing is a common maintenance activity used to improve pipe hydraulics and to remove pollutants in storm drainage systems. Flushing may be designed to hydraulically convey accumulated material to strategic locations, such as an open channel, another point where flushing will be initiated, or the sanitary sewer and the treatment facilities, thus preventing re-suspension and overflow of a portion of the solids during storm events. Flushing prevents “plug flow” discharges of concentrated pollutant loadings and sediments. Deposits can hinder the designed conveyance capacity of the storm drain system and potentially cause backwater conditions in severe cases of clogging.

Storm drain flushing usually takes place along segments of pipe with grades that are too flat to maintain adequate velocity to keep particles in suspension. An upstream manhole is selected to place an inflatable device that temporarily plugs the pipe. Further upstream, water is pumped into the line to create a flushing wave. When the upstream reach of pipe is sufficiently full to cause a flushing wave, the inflated device is rapidly deflated with the assistance of a vacuum pump, thereby releasing the backed up water and resulting in the cleaning of the storm drain segment.

To further reduce impacts of stormwater pollution, a second inflatable device placed well downstream may be used to recollect the water after the force of the flushing wave has dissipated. A pump may then be used to transfer the water and accumulated material to the sanitary sewer for treatment. In some cases, an interceptor structure may be more practical or required to recollect the flushed waters.

It has been found that cleansing efficiency of periodic flush waves is dependent upon flush volume, flush discharge rate, sewer slope, sewer length, sewer flow rate, sewer diameter, and population density. As a rule of thumb, the length of line to be flushed should not exceed 700 feet. At this maximum recommended length, the percent removal efficiency ranges between 65-75% for organics and 55-65% for dry weather grit/inorganic material. The percent removal efficiency drops rapidly beyond that. Water is commonly supplied by a water truck, but fire hydrants can also supply water. To make the best use of water, it is recommended that reclaimed water be used if allowed or that fire hydrant line flushing coincide with storm sewer flushing.

# **Drainage System Maintenance SC-44**

---

## **References and Resources**

City of Seattle, Seattle Public Utilities Department of Planning and Development, 2009. *Stormwater Manual Vol. 1 Source Control Technical Requirements Manual*.

Knox County Tennessee *Stormwater Management Manual* Chapter 5 Drainage System Maintenance, 2008. Available online at:  
[http://www.knoxcounty.org/stormwater/manual/Volume%201/knoxco\\_swmm\\_v1\\_chap5\\_jan2008.pdf](http://www.knoxcounty.org/stormwater/manual/Volume%201/knoxco_swmm_v1_chap5_jan2008.pdf).

US EPA. Storm Drain System Cleaning, 2012. Available online at:  
<http://cfpub.epa.gov/npdes/stormwater/menuofbmps/index.cfm?action=browse&button=detail&bmp=102>.



## Design Objectives

- Maximize Infiltration
- Provide Retention
- Slow Runoff
- Minimize Impervious Land Coverage
- Prohibit Dumping of Improper Materials
- Contain Pollutants
- Collect and Convey

## Description

Irrigation water provided to landscaped areas may result in excess irrigation water being conveyed into stormwater drainage systems.

## Approach

Project plan designs for development and redevelopment should include application methods of irrigation water that minimize runoff of excess irrigation water into the stormwater conveyance system.

## Suitable Applications

Appropriate applications include residential, commercial and industrial areas planned for development or redevelopment. (Detached residential single-family homes are typically excluded from this requirement.)

## Design Considerations

### ***Designing New Installations***

The following methods to reduce excessive irrigation runoff should be considered, and incorporated and implemented where determined applicable and feasible by the Permittee:

- Employ rain-triggered shutoff devices to prevent irrigation after precipitation.
- Design irrigation systems to each landscape area's specific water requirements.
- Include design featuring flow reducers or shutoff valves triggered by a pressure drop to control water loss in the event of broken sprinkler heads or lines.
- Implement landscape plans consistent with County or City water conservation resolutions, which may include provision of water sensors, programmable irrigation times (for short cycles), etc.



- Design timing and application methods of irrigation water to minimize the runoff of excess irrigation water into the storm water drainage system.
- Group plants with similar water requirements in order to reduce excess irrigation runoff and promote surface filtration. Choose plants with low irrigation requirements (for example, native or drought tolerant species). Consider design features such as:
  - Using mulches (such as wood chips or bar) in planter areas without ground cover to minimize sediment in runoff
  - Installing appropriate plant materials for the location, in accordance with amount of sunlight and climate, and use native plant materials where possible and/or as recommended by the landscape architect
  - Leaving a vegetative barrier along the property boundary and interior watercourses, to act as a pollutant filter, where appropriate and feasible
  - Choosing plants that minimize or eliminate the use of fertilizer or pesticides to sustain growth
- Employ other comparable, equally effective methods to reduce irrigation water runoff.

### ***Redeveloping Existing Installations***

Various jurisdictional stormwater management and mitigation plans (SUSMP, WQMP, etc.) define “redevelopment” in terms of amounts of additional impervious area, increases in gross floor area and/or exterior construction, and land disturbing activities with structural or impervious surfaces. The definition of “redevelopment” must be consulted to determine whether or not the requirements for new development apply to areas intended for redevelopment. If the definition applies, the steps outlined under “designing new installations” above should be followed.

### **Other Resources**

A Manual for the Standard Urban Stormwater Mitigation Plan (SUSMP), Los Angeles County Department of Public Works, May 2002.

Model Standard Urban Storm Water Mitigation Plan (SUSMP) for San Diego County, Port of San Diego, and Cities in San Diego County, February 14, 2002.

Model Water Quality Management Plan (WQMP) for County of Orange, Orange County Flood Control District, and the Incorporated Cities of Orange County, Draft February 2003.

Ventura Countywide Technical Guidance Manual for Stormwater Quality Control Measures, July 2002.



## Design Objectives

- Maximize Infiltration
- Provide Retention
- Slow Runoff
- Minimize Impervious Land Coverage
- Prohibit Dumping of Improper Materials
- Contain Pollutants
- Collect and Convey

## Description

Waste materials dumped into storm drain inlets can have severe impacts on receiving and ground waters. Posting notices regarding discharge prohibitions at storm drain inlets can prevent waste dumping. Storm drain signs and stencils are highly visible source controls that are typically placed directly adjacent to storm drain inlets.

## Approach

The stencil or affixed sign contains a brief statement that prohibits dumping of improper materials into the urban runoff conveyance system. Storm drain messages have become a popular method of alerting the public about the effects of and the prohibitions against waste disposal.

## Suitable Applications

Stencils and signs alert the public to the destination of pollutants discharged to the storm drain. Signs are appropriate in residential, commercial, and industrial areas, as well as any other area where contributions or dumping to storm drains is likely.

## Design Considerations

Storm drain message markers or placards are recommended at all storm drain inlets within the boundary of a development project. The marker should be placed in clear sight facing toward anyone approaching the inlet from either side. All storm drain inlet locations should be identified on the development site map.

## *Designing New Installations*

The following methods should be considered for inclusion in the project design and show on project plans:

- Provide stenciling or labeling of all storm drain inlets and catch basins, constructed or modified, within the project area with prohibitive language. Examples include “NO DUMPING



– DRAINS TO OCEAN” and/or other graphical icons to discourage illegal dumping.

- Post signs with prohibitive language and/or graphical icons, which prohibit illegal dumping at public access points along channels and creeks within the project area.

Note - Some local agencies have approved specific signage and/or storm drain message placards for use. Consult local agency stormwater staff to determine specific requirements for placard types and methods of application.

### ***Redeveloping Existing Installations***

Various jurisdictional stormwater management and mitigation plans (SUSMP, WQMP, etc.) define “redevelopment” in terms of amounts of additional impervious area, increases in gross floor area and/or exterior construction, and land disturbing activities with structural or impervious surfaces. If the project meets the definition of “redevelopment”, then the requirements stated under “designing new installations” above should be included in all project design plans.

### **Additional Information**

#### ***Maintenance Considerations***

- Legibility of markers and signs should be maintained. If required by the agency with jurisdiction over the project, the owner/operator or homeowner’s association should enter into a maintenance agreement with the agency or record a deed restriction upon the property title to maintain the legibility of placards or signs.

#### ***Placement***

- Signage on top of curbs tends to weather and fade.
- Signage on face of curbs tends to be worn by contact with vehicle tires and sweeper brooms.

### **Supplemental Information**

#### ***Examples***

- Most MS4 programs have storm drain signage programs. Some MS4 programs will provide stencils, or arrange for volunteers to stencil storm drains as part of their outreach program.

### **Other Resources**

A Manual for the Standard Urban Stormwater Mitigation Plan (SUSMP), Los Angeles County Department of Public Works, May 2002.

Model Standard Urban Storm Water Mitigation Plan (SUSMP) for San Diego County, Port of San Diego, and Cities in San Diego County, February 14, 2002.

Model Water Quality Management Plan (WQMP) for County of Orange, Orange County Flood Control District, and the Incorporated Cities of Orange County, Draft February 2003.

Ventura Countywide Technical Guidance Manual for Stormwater Quality Control Measures, July 2002.



## Design Objectives

- Maximize Infiltration
- Provide Retention
- Slow Runoff
- Minimize Impervious Land Coverage
- Prohibit Dumping of Improper Materials
- Contain Pollutants
- Collect and Convey

## Description

Several measures can be taken to prevent operations at maintenance bays and loading docks from contributing a variety of toxic compounds, oil and grease, heavy metals, nutrients, suspended solids, and other pollutants to the stormwater conveyance system.

## Approach

In designs for maintenance bays and loading docks, containment is encouraged. Preventative measures include overflow containment structures and dead-end sumps. However, in the case of loading docks from grocery stores and warehouse/distribution centers, engineered infiltration systems may be considered.

## Suitable Applications

Appropriate applications include commercial and industrial areas planned for development or redevelopment.

## Design Considerations

Design requirements for vehicle maintenance and repair are governed by Building and Fire Codes, and by current local agency ordinances, and zoning requirements. The design criteria described in this fact sheet are meant to enhance and be consistent with these code requirements.

## *Designing New Installations*

Designs of maintenance bays should consider the following:

- Repair/maintenance bays and vehicle parts with fluids should be indoors; or designed to preclude urban run-on and runoff.
- Repair/maintenance floor areas should be paved with Portland cement concrete (or equivalent smooth impervious surface).



- Repair/maintenance bays should be designed to capture all wash water leaks and spills. Provide impermeable berms, drop inlets, trench catch basins, or overflow containment structures around repair bays to prevent spilled materials and wash-down waters from entering the storm drain system. Connect drains to a sump for collection and disposal. Direct connection of the repair/maintenance bays to the storm drain system is prohibited. If required by local jurisdiction, obtain an Industrial Waste Discharge Permit.
- Other features may be comparable and equally effective.

The following designs of loading/unloading dock areas should be considered:

- Loading dock areas should be covered, or drainage should be designed to preclude urban run-on and runoff.
- Direct connections into storm drains from depressed loading docks (truck wells) are prohibited.
- Below-grade loading docks from grocery stores and warehouse/distribution centers of fresh food items should drain through water quality inlets, or to an engineered infiltration system, or an equally effective alternative. Pre-treatment may also be required.
- Other features may be comparable and equally effective.

### ***Redeveloping Existing Installations***

Various jurisdictional stormwater management and mitigation plans (SUSMP, WQMP, etc.) define “redevelopment” in terms of amounts of additional impervious area, increases in gross floor area and/or exterior construction, and land disturbing activities with structural or impervious surfaces. The definition of “redevelopment” must be consulted to determine whether or not the requirements for new development apply to areas intended for redevelopment. If the definition applies, the steps outlined under “designing new installations” above should be followed.

### **Additional Information**

Stormwater and non-stormwater will accumulate in containment areas and sumps with impervious surfaces. Contaminated accumulated water must be disposed of in accordance with applicable laws and cannot be discharged directly to the storm drain or sanitary sewer system without the appropriate permit.

### **Other Resources**

A Manual for the Standard Urban Stormwater Mitigation Plan (SUSMP), Los Angeles County Department of Public Works, May 2002.

Model Standard Urban Storm Water Mitigation Plan (SUSMP) for San Diego County, Port of San Diego, and Cities in San Diego County, February 14, 2002.

Model Water Quality Management Plan (WQMP) for County of Orange, Orange County Flood Control District, and the Incorporated Cities of Orange County, Draft February 2003.

Ventura Countywide Technical Guidance Manual for Stormwater Quality Control Measures, July 2002.



## Description

Trash storage areas are areas where a trash receptacle (s) are located for use as a repository for solid wastes. Stormwater runoff from areas where trash is stored or disposed of can be polluted. In addition, loose trash and debris can be easily transported by water or wind into nearby storm drain inlets, channels, and/or creeks. Waste handling operations that may be sources of stormwater pollution include dumpsters, litter control, and waste piles.

## Approach

This fact sheet contains details on the specific measures required to prevent or reduce pollutants in stormwater runoff associated with trash storage and handling. Preventative measures including enclosures, containment structures, and impervious pavements to mitigate spills, should be used to reduce the likelihood of contamination.

## Suitable Applications

Appropriate applications include residential, commercial and industrial areas planned for development or redevelopment. (Detached residential single-family homes are typically excluded from this requirement.)

## Design Considerations

Design requirements for waste handling areas are governed by Building and Fire Codes, and by current local agency ordinances and zoning requirements. The design criteria described in this fact sheet are meant to enhance and be consistent with these code and ordinance requirements. Hazardous waste should be handled in accordance with legal requirements established in Title 22, California Code of Regulation.

Wastes from commercial and industrial sites are typically hauled by either public or commercial carriers that may have design or access requirements for waste storage areas. The design criteria in this fact sheet are recommendations and are not intended to be in conflict with requirements established by the waste hauler. The waste hauler should be contacted prior to the design of your site trash collection areas. Conflicts or issues should be discussed with the local agency.

## *Designing New Installations*

Trash storage areas should be designed to consider the following structural or treatment control BMPs:

- Design trash container areas so that drainage from adjoining roofs and pavement is diverted around the area(s) to avoid run-on. This might include berming or grading the waste handling area to prevent run-on of stormwater.
- Make sure trash container areas are screened or walled to prevent off-site transport of trash.

## Design Objectives

- Maximize Infiltration
- Provide Retention
- Slow Runoff
- Minimize Impervious Land Coverage
- Prohibit Dumping of Improper Materials
- Contain Pollutants
- Collect and Convey



- Use lined bins or dumpsters to reduce leaking of liquid waste.
- Provide roofs, awnings, or attached lids on all trash containers to minimize direct precipitation and prevent rainfall from entering containers.
- Pave trash storage areas with an impervious surface to mitigate spills.
- Do not locate storm drains in immediate vicinity of the trash storage area.
- Post signs on all dumpsters informing users that hazardous materials are not to be disposed of therein.

### ***Redeveloping Existing Installations***

Various jurisdictional stormwater management and mitigation plans (SUSMP, WQMP, etc.) define “redevelopment” in terms of amounts of additional impervious area, increases in gross floor area and/or exterior construction, and land disturbing activities with structural or impervious surfaces. The definition of “redevelopment” must be consulted to determine whether or not the requirements for new development apply to areas intended for redevelopment. If the definition applies, the steps outlined under “designing new installations” above should be followed.

### **Additional Information**

#### ***Maintenance Considerations***

The integrity of structural elements that are subject to damage (i.e., screens, covers, and signs) must be maintained by the owner/operator. Maintenance agreements between the local agency and the owner/operator may be required. Some agencies will require maintenance deed restrictions to be recorded of the property title. If required by the local agency, maintenance agreements or deed restrictions must be executed by the owner/operator before improvement plans are approved.

### **Other Resources**

A Manual for the Standard Urban Stormwater Mitigation Plan (SUSMP), Los Angeles County Department of Public Works, May 2002.

Model Standard Urban Storm Water Mitigation Plan (SUSMP) for San Diego County, Port of San Diego, and Cities in San Diego County, February 14, 2002.

Model Water Quality Management Plan (WQMP) for County of Orange, Orange County Flood Control District, and the Incorporated Cities of Orange County, Draft February 2003.

Ventura Countywide Technical Guidance Manual for Stormwater Quality Control Measures, July 2002.

# **Attachment F Infiltration Report**



**SOUTHERN  
CALIFORNIA  
GEOTECHNICAL**  
*A California Corporation*

June 8, 2021

Hillwood  
901 Via Piemonte, Suite 175  
Ontario, California 91764

Attention: Mr. Bob Close  
Vice President

Project No.: **21G166-2**

Subject: **Results of Infiltration Testing**  
Proposed Gateway South Building 8  
NWC Valley View Avenue and Norman Road  
San Bernardino, California

Reference: Geotechnical Investigation, Proposed Gateway South Building 8, NWC Valley View Avenue and Norman Road, San Bernardino, California, prepared by Southern California Geotechnical, Inc. (SCG), prepared for Hillwood, SCG Project No. 21G166-1, dated June 7, 2021

Mr. Close:

In accordance with your request, we have conducted infiltration testing at the subject site. We are pleased to present this report summarizing the results of the infiltration testing and our design recommendations.

### **Scope of Services**

The scope of services performed for this project was in general accordance with our Proposal No. 21P231, dated April 22, 2021. The scope of services included site reconnaissance, subsurface exploration, field testing, and engineering analysis to determine the infiltration rates of the onsite soils. The infiltration testing was performed in general accordance with the Technical Guidance Document for Water Quality Management Plans prepared for the County of San Bernardino Areawide Stormwater Program dated June 7, 2013. The San Bernardino County standards defer to guidelines published by Riverside County Department of Environmental Health (RCDEH).

### **Site and Project Description**

The subject site is located at the northwest corner of Valley View Avenue and Norman Road in San Bernardino, California. The site is bounded to the north by the existing Gateway South Building 6 development and single-family residences (SFRs), to the west by SFRs and Foisy Street, to the south by Norman Road and to the east by Valley View Avenue. The general location of the site is illustrated on the Site Location Map, included as Plate 1 of this report.

The site is an "L"-shaped property consisting of several rectangular to irregular-shaped parcels, totaling 13.19± acres in size. The western parcels of the site are presently developed with several residential lots. The lots include SFRs and one lot is being used for automobile repair

and storage. The northern portions of these lots are vacant and undeveloped. The vacant areas possess tilled soil, assumed to be associated with previous agricultural activities. Ground surface cover in the remaining areas of these western parcels consists of exposed soil, medium trees, limited areas of Portland cement concrete flatwork and crushed aggregate base in the driveway of the automobile repair and storage parcel. The eastern parcels of the site are comprised of existing storm-water infiltration basins. Concrete spillways are present along the eastern and southern property lines on the slopes of the basin. Ground surface cover within the basin consists of exposed soil and sparse to moderate native grass and weed growth.

Detailed topographic information was not available at the time of this report. Based on elevations obtained from Google Earth and visual observations made at the time of the subsurface investigation, the eastern portion of the site is relatively level, except the slopes surrounding the basin, which possess an approximate 3h:1v to 5h:1v slope face. The slopes in this area are 5 to 7± feet higher in elevation than the bottom of the basin. The top of the slopes are level with the surrounding topography. The western portion of the site is relatively level, with minor undulations in the vacant areas, assumed to be due to previous agricultural activities.

### **Proposed Development**

Based on the conceptual site plan (Scheme 8 Rev 1) provided to our office by the client, the site will be developed with one (1) new commercial/industrial building. The building, 309,040± ft<sup>2</sup> in size, will be located in the south-central area of the site. The building will be constructed with dock-high doors along a portion of the north building wall. The new building will be surrounded by asphaltic concrete pavements in the automobile parking and drive areas, and Portland cement concrete pavements in the truck court and truck traffic areas. We expect the new development will also include areas of concrete flatwork and landscape planters.

The proposed development will use on-site storm water infiltration. Based on electronic mail correspondence with representatives of Thienes Engineering, the project civil engineer, the infiltration system will consist of a below-grade chamber located to the northern and west of the proposed Gateway South Building 8 and an infiltration basin located to the north of the proposed building. The bottom of the infiltration chambers and basin will be approximately 12 to 20± feet below the existing site grades.

### **Concurrent Study**

SCG performed a concurrent geotechnical investigation at the subject site, referenced above. As part of this investigation, a total of five (5) borings were advanced to depths of 15 to 50± feet below the currently existing side grades.

Artificial fill soils were encountered at the ground surface of Boring Nos. B-3 through B-5, extending from depths of 5½ to 12± feet below ground surface. The fill soils generally consist of loose to dense fine sands, fine to coarse sands, silty fine sands and silty fine to coarse sands. The fill soils possess a disturbed and mottled appearance, with some samples possessing debris such as PCC fragments and cloth, resulting in their classification as artificial fill. Native alluvium was encountered beneath the fill soils of Boring Nos. B-3 through B-5 and at the ground surface of all remaining borings, extending to at least the maximum depth explored of 50± feet below

ground surface. The native alluvial soils generally consist of loose to very dense fine sands, fine to coarse sands, silty fine sands, silty fine to coarse sands and fine sandy silts. Boring No. B-1 encountered a layer consisting of very stiff silty clay with some fine sand at a depth of 47± feet below the existing site grades, extending to the maximum depth explored of 50± feet. Occasional layers of medium dense to dense silt and interbedded fine sand and fine sandy silt were also encountered. The majority of samples possess trace to little iron oxide staining. Occasionally, some samples possess trace to little calcareous veining and nodules.

### Groundwater

Free water was encountered during drilling at Boring Nos. B-1 and B-5. Boring No. B-1 encountered perched water at 28½ and 29± feet below ground surface. Delayed groundwater readings were not feasible due to caving.

## **Subsurface Exploration**

### Scope of Exploration

The subsurface exploration conducted for the infiltration testing consisted of four (4) infiltration test borings, advanced to depths of 12 to 20± feet below the existing site grades. The infiltration borings were advanced using a truck-mounted drilling rig, equipped with 8-inch-diameter hollow-stem augers and were logged during drilling by a member of our staff. The approximate locations of the infiltration test borings (identified as I-1 through I-4) are indicated on the Infiltration Test Location Plan, enclosed as Plate 2 of this report.

Upon the completion of the infiltration borings, the bottom of each test boring was covered with 2± inches of clean ¾-inch gravel. A sufficient length of 3-inch-diameter perforated PVC casing was then placed into each test hole so that the PVC casing extended from the bottom of the test hole to the ground surface. Clean ¾-inch gravel was then installed in the annulus surrounding the PVC casing.

### Geotechnical Conditions

Artificial fill soils were encountered at the ground surface at Boring No. I-4, extending to a depth of 17± feet below ground surface. The fill soils generally consist of loose to medium dense fine sands and silty fine sands. A layer of dense silty fine sands were encountered at a depth of 13½ feet. The fill soils possess a disturbed and mottled appearance, with some samples possessing debris such as brick fragments, resulting in their classification as artificial fill. Native alluvial soils were encountered beneath the fill soils and at the ground surface at all of the infiltration test boring locations. The alluvial soils consist of very loose to very dense fine sandy silts, silty fine sands, gravelly sands and well-graded sands, with varying amounts of fine to coarse gravel extending to at least 20± feet below the existing site grades.

### Groundwater

As previously stated, the static groundwater table is considered to have been present at a depth of 28½ and 29± feet below the existing site grades at the time of subsurface exploration for the geotechnical investigation.

As part of our research, we reviewed available groundwater data in order to determine the historic high groundwater level for the site. USGS Bulletin 1898 (Matti and Carson, 1991) indicates that the minimum historic depth to groundwater at the site is 8± feet. Recent water level data was obtained from the California State Water Resources Control Board, GeoTracker, website, <https://geotracker.waterboards.ca.gov/>. One monitoring well on record is located 4,978± feet north of the site. Water level readings within these monitoring wells indicate a high groundwater level of 74± feet below the ground surface in April 2015.

### **Infiltration Testing**

As previously mentioned, the infiltration testing was performed in general accordance with the guidelines published in Riverside County – Low Impact Development BMP Design Handbook – Section 2.3 of Appendix A, which apply to San Bernardino County.

#### Pre-soaking

In accordance with the county infiltration standards, the pre-soaking process consisted of filling each test boring with clear water so that the water level reaches a level of at least 5 times the hole’s radius above the gravel at the bottom of the holes. Pre-soaking was considered complete after all of the water had percolated through each test hole or after 15 hours since initiating the pre-soak.

#### Infiltration Testing

Following the pre-soaking process of the infiltration test borings, SCG performed the infiltration testing. Each test hole was filled with water to a depth of at least 5 times the hole’s radius above the gravel at the bottom of each test hole. In accordance with the county infiltration guidelines, in areas where “sandy soils” were encountered at the bottom of the infiltration test borings (where 6 inches of water infiltrated into the surrounding soils in less than 25 minutes for two (2) consecutive readings), readings were taken at 10-minute intervals for a total of 1 hour at each of these test locations. After each reading, water was added to the borings so that the depth of the water was at least 5 times the radius of the hole. The water level readings are presented on the spreadsheets enclosed with this report. The infiltration rates for each of the timed intervals are also tabulated on the spreadsheets.

The infiltration rates from the test are tabulated in inches per hour. In accordance with the typically accepted practice, it is recommended that the most conservative reading from the latter part of the infiltration tests be used as the design infiltration rate. The rates are summarized below:

<b><u>Infiltration Test No.</u></b>	<b><u>Depth (feet)</u></b>	<b><u>Soil Description</u></b>	<b><u>Infiltration Rate (inches/hour)</u></b>
I-1	12	Gray Brown fine Sandy Silt, trace medium to coarse Sand	2.8
I-2	12	Gray Brown Gravelly fine to medium Sand, some Silt, little coarse Sand	13.1

I-3	12	Gray Brown Silty fine to medium Sand	1.0
I-4	20	Gray Gravelly fine to coarse Sand, little Silt	20.0

## **Laboratory Testing**

### Moisture Content

The moisture contents for the recovered soil samples within the borings were determined in accordance with ASTM D-2216 and are expressed as a percentage of the dry weight. These test results are presented on the Boring Logs.

### Grain Size Analysis

The grain size distribution of selected soils collected from the base of each infiltration test boring have been determined using a range of wire mesh screens. These tests were performed in general accordance with ASTM D-422 and/or ASTM D-1140. The weight of the portion of the sample retained on each screen is recorded and the percentage finer or coarser of the total weight is calculated. The results of these tests are presented on Plates C-1 through C-2 of this report.

## **Design Recommendations**

Four (4) infiltration tests were performed at the subject site. As noted above, the infiltration rates at these locations vary from 1.0 to 20.0 inches per hour. Based on the results of Infiltration Test Nos. I-1 through I-4, we recommend infiltration rates as follows:

<b>Infiltration Tests</b>	<b>Location</b>	<b>Infiltration Rate (Inches per Hour)</b>
I-1 and I-2	North of proposed building	2.8
I-3	West of proposed building	1.0
I-4	Proposed basin north of proposed building	20.0

We recommend that a representative from the geotechnical engineer be on-site during the construction of the proposed infiltration systems to identify the soil classification at the base of each chamber system. It should be confirmed that the soils at the base of the proposed infiltration systems correspond with those presented in this report to ensure that the performance of the systems will be consistent with the rates reported herein.

The design of the proposed storm water infiltration systems should be performed by the project civil engineer, in accordance with the City of San Bernardino and/or San Bernardino County guidelines. However, it is recommended that the system be constructed so as to facilitate removal of silt and clay, or other deleterious materials from any water that may enter the systems. The presence of such materials would decrease the effective infiltration rates. **It is recommended that the project civil engineer apply an appropriate factor of safety.**



**The infiltration rates recommended above are based on the assumption that only clean water will be introduced to the subsurface profile. Any fines, debris, or organic materials could significantly impact the infiltration rates.** It should be noted that the recommended infiltration rates are based on infiltration testing at four (4) discrete locations and the overall infiltration rates of the storm water infiltration systems could vary considerably.

### **Infiltration Rate Considerations**

The infiltration rates presented herein was determined in accordance with the San Bernardino County guidelines and are considered valid only for the time and place of the actual test. Varying subsurface conditions will exist in other areas of the site, which could alter the recommended infiltration rates presented above. The infiltration rates will decline over time between maintenance cycles as silt or clay particles accumulate on the BMP surface. The infiltration rate is highly dependent upon a number of factors, including density, silt and clay content, grainsize distribution throughout the range of particle sizes, and particle shape. Small changes in these factors can cause large changes in the infiltration rates.

Infiltration rates are based on unsaturated flow. As water is introduced into soils by infiltration, the soils become saturated and the wetting front advances from the unsaturated zone to the saturated zone. Once the soils become saturated, infiltration rates become zero, and water can only move through soils by hydraulic conductivity at a rate determined by pressure head and soil permeability. Changes in soil moisture content will affect the infiltration rate. Infiltration rates should be expected to decrease until the soils become saturated. Soil permeability values will then govern groundwater movement. Permeability values may be on the order of 10 to 20 times less than infiltration rates. The system designer should incorporate adequate factors of safety and allow for overflow design into appropriate traditional storm drain systems, which would transport storm water off-site.

### **Construction Considerations**

The infiltration rates presented in this report are specific to the tested locations and tested depths. Infiltration rates can be significantly reduced if the soils are exposed to excessive disturbance or compaction during construction. Compaction of the soils at the bottom of the infiltration system can significantly reduce the infiltration ability of the basins. Therefore, the subgrade soils within proposed infiltration system areas should not be over-excavated, undercut or compacted in any significant manner. **It is recommended that a note to this effect be added to the project plans and/or specifications.**

We recommend that a representative from the geotechnical engineer be on-site during the construction of the proposed infiltration systems to identify the soil classification at the base of each system. It should be confirmed that the soils at the base of the proposed infiltration systems correspond with those presented in this report to ensure that the performance of the systems will be consistent with the rates reported herein.

We recommend that scrapers and other rubber-tired heavy equipment not be operated on the basin bottom, or at levels lower than 2 feet above the bottom of the system, particularly within basins. As such, the bottom 24 inches of the infiltration systems should be excavated with non-rubber-tired equipment, such as excavators.

## **Infiltration Chamber Maintenance**

The proposed project may include infiltration chambers. Water flowing into these chambers will carry some level of sediment. This layer has the potential to significantly reduce the infiltration rate of the chamber subgrade soils. Therefore, a formal chamber maintenance program should be established to ensure that these silt and clay deposits are removed from the chamber on a regular basis.

## **Basin Maintenance**

The proposed project may include infiltration basins. Water flowing into these basins will carry some level of sediment. Wind-blown sediments and erosion of the basin side walls will also contribute to sediment deposition at the bottom of the basin. This layer has the potential to significantly reduce the infiltration rate of the basin subgrade soils. Therefore, a formal basin maintenance program should be established to ensure that these silt and clay deposits are removed from the basin on a regular basis. Appropriate vegetation on the basin sidewalls and bottom may reduce erosion and sediment deposition.

Basin maintenance should also include measures to prevent animal burrows, and to repair any burrows or damage caused by such. Animal burrows in the basin sidewalls can significantly increase the risk of erosion and piping failures.

## **Location of Infiltration Systems**

The use of on-site storm water infiltration systems carries a risk of creating adverse geotechnical conditions. Increasing the moisture content of the soil can cause the soil to lose internal shear strength and increase its compressibility, resulting in a change in the designed engineering properties. Overlying structures and pavements in the infiltration area could potentially be damaged due to saturation of the subgrade soils. **The proposed infiltration systems for this site should be located at least 25 feet away from any structures, including retaining walls.** Even with this provision of locating the infiltration system at least 25 feet from the building(s), it is possible that infiltrating water into the subsurface soils could have an adverse effect on the proposed or existing structures. It should also be noted that utility trenches which happen to collect storm water can also serve as conduits to transmit storm water toward the structure, depending on the slope of the utility trench. Therefore, consideration should also be given to the proposed locations of underground utilities which may pass near the proposed infiltration system.

The infiltration system designer should also give special consideration to the effect that the proposed infiltration systems may have on nearby subterranean structures, open excavations, or descending slopes. In particular, infiltration systems should not be located near the crest of descending slopes, particularly where the slopes are comprised of granular soils. Such systems will require specialized design and analysis to evaluate the potential for slope instability, piping failures and other phenomena that typically apply to earthen dam design. This type of analysis is beyond the scope of this infiltration test report, but these factors should be considered by the infiltration system designer when locating the infiltration systems.

## **General Comments**

This report has been prepared as an instrument of service for use by the client in order to aid in the evaluation of this property and to assist the architects and engineers in the design and preparation of the project plans and specifications. This report may be provided to the contractor(s) and other design consultants to disclose information relative to the project. However, this report is not intended to be utilized as a specification in and of itself, without appropriate interpretation by the project architect, structural engineer, and/or civil engineer. The design of the infiltration system is the responsibility of the civil engineer. The role of the geotechnical engineer is limited to determination of infiltration rate only. By using the design infiltration rates contained herein, the civil engineer agrees to indemnify, defend, and hold harmless the geotechnical engineer for all aspects of the design and performance of the infiltration system. The reproduction and distribution of this report must be authorized by the client and Southern California Geotechnical, Inc. Furthermore, any reliance on this report by an unauthorized third party is at such party's sole risk, and we accept no responsibility for damage or loss which may occur. The analysis of this site was based on a subsurface profile interpolated from limited discrete soil samples. While the materials encountered in the project area are considered to be representative of the total area, some variations should be expected between boring locations and testing depths. If the conditions encountered during construction vary significantly from those detailed herein, we should be contacted immediately to determine if the conditions alter the recommendations contained herein.

This report has been based on assumed or provided characteristics of the proposed development. It is recommended that the owner, client, architect, structural engineer, and civil engineer carefully review these assumptions to ensure that they are consistent with the characteristics of the proposed development. If discrepancies exist, they should be brought to our attention to verify that they do not affect the conclusions and recommendations contained herein. We also recommend that the project plans and specifications be submitted to our office for review to verify that our recommendations have been correctly interpreted. The analysis, conclusions, and recommendations contained within this report have been promulgated in accordance with generally accepted professional geotechnical engineering practice. No other warranty is implied or expressed.

## **Closure**

We sincerely appreciate the opportunity to be of service on this project. We look forward to providing additional consulting services during the course of the project. If we may be of further assistance in any manner, please contact our office.

Respectfully Submitted,

SOUTHERN CALIFORNIA GEOTECHNICAL, INC.



Ricardo Frias, RCE 91772  
Project Engineer



Robert G. Trazo, GE 2655  
Principal Engineer



Distribution: (1) Addressee

- Enclosures:
- Plate 1 - Site Location Map
  - Plate 2 - Infiltration Test Location Plan
  - Boring Log Legend and Logs (6 pages)
  - Infiltration Test Results Spreadsheets (4 pages)
  - Grain Size Distribution Graphs (4 pages)

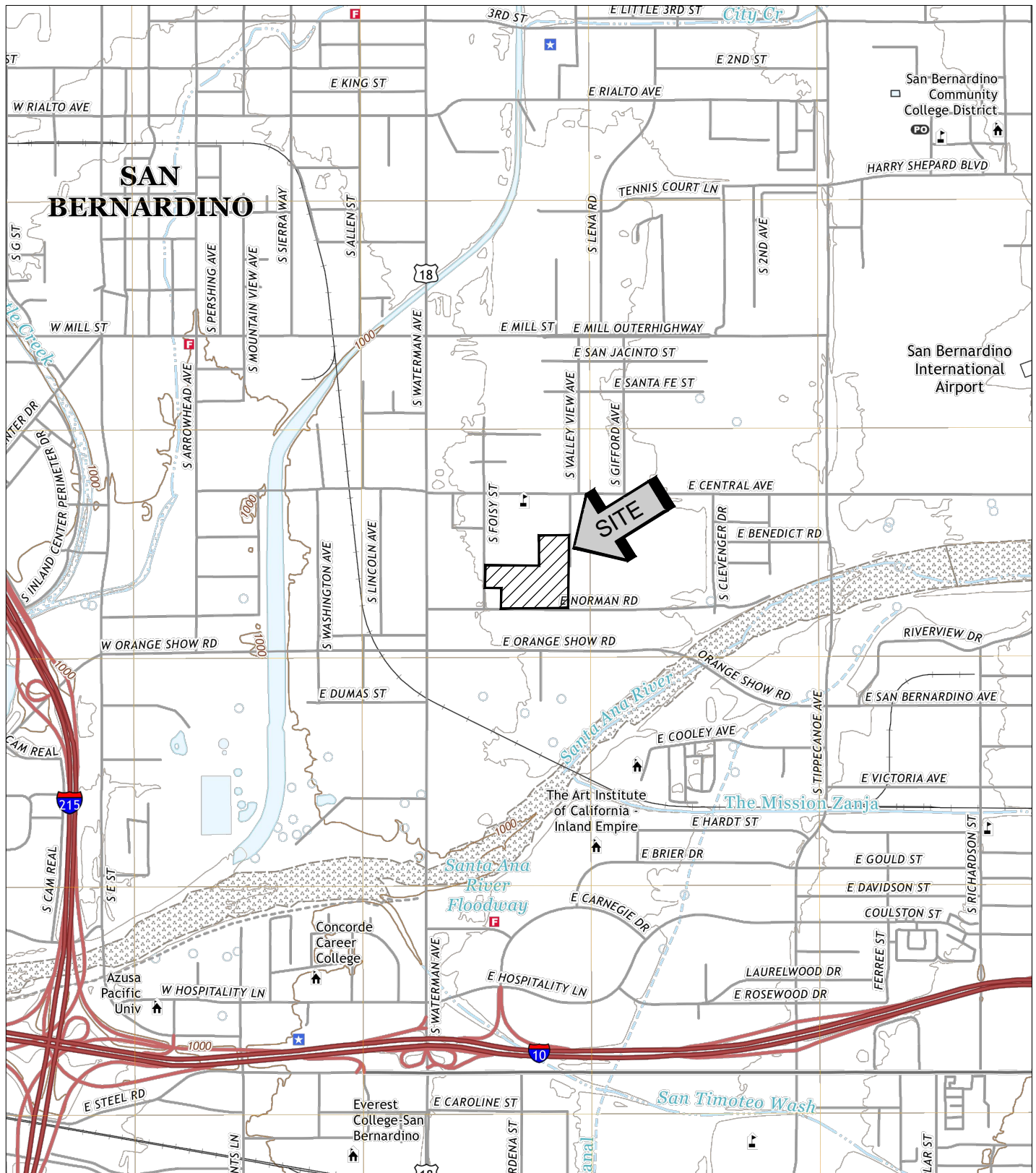

SOURCE: USGS TOPOGRAPHIC MAP OF THE STEELE PEAK AND PERRIS QUADRANGLES, RIVERSIDE COUNTY, CALIFORNIA, 2018.





<b>SITE LOCATION MAP</b>	
<b>PROPOSED GATEWAY SOUTH BUILDING 8</b>	
<b>SAN BERNARDINO, CALIFORNIA</b>	
SCALE: 1" = 2000'	 <b>SOUTHERN CALIFORNIA GEOTECHNICAL</b>
DRAWN: JAZ	
CHKD: RF	
SCG PROJECT 21G166-2	
<b>PLATE 1</b>	

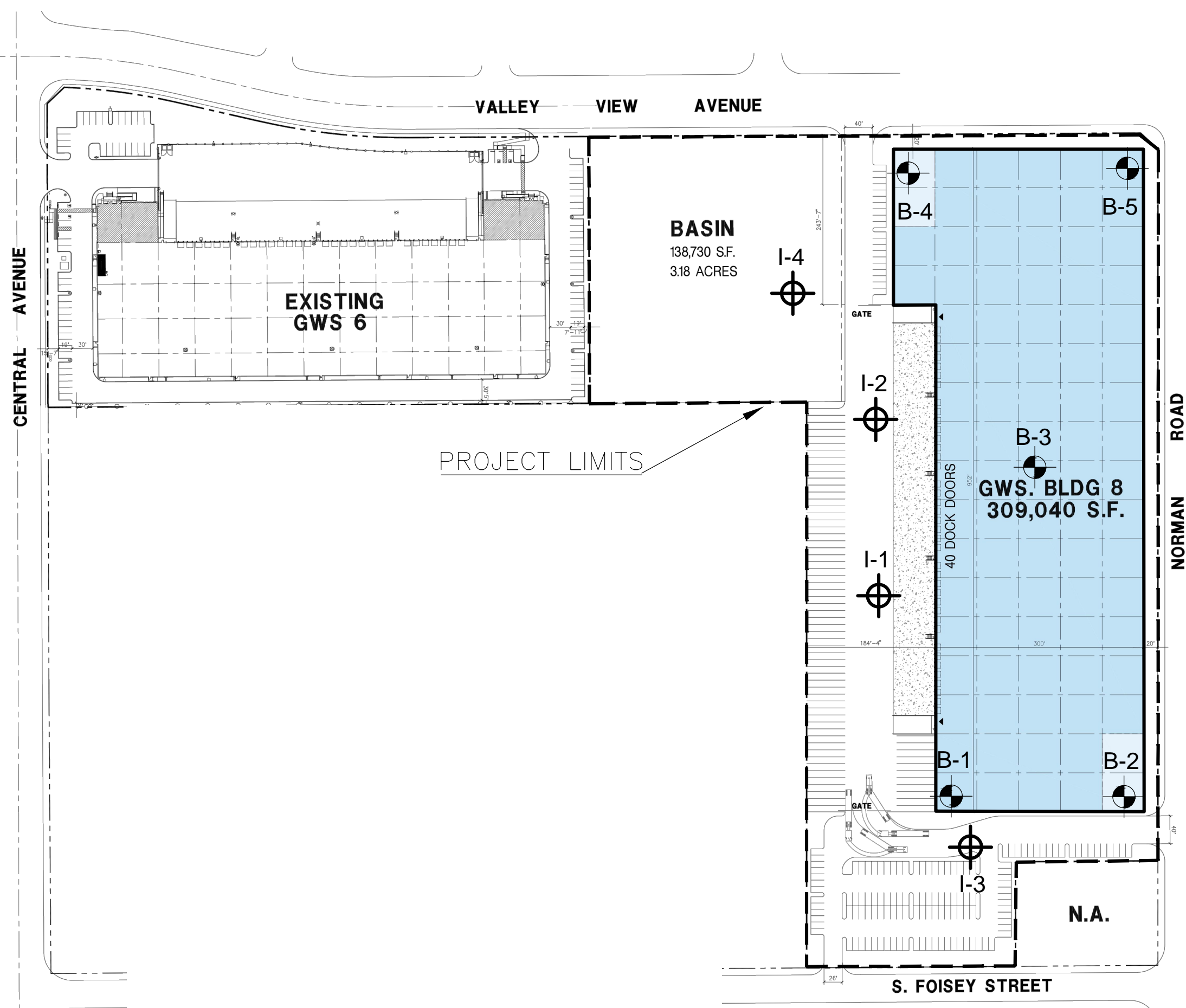











**GEOTECHNICAL LEGEND**

-  APPROXIMATE INFILTRATION TEST LOCATION
-  APPROXIMATE BORING LOCATION (SCG PROJECT NO. 21G166-1)

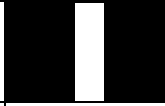
NOTE: BASE MAP PREPARED BY HPA, INC.

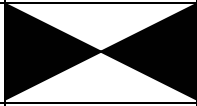
<b>INFILTRATION TEST LOCATION PLAN</b>	
PROPOSED GATEWAY SOUTH BUILDING 8	
SAN BERNARDINO, CALIFORNIA	
SCALE: 1" = 150'	 <b>SOUTHERN CALIFORNIA GEOTECHNICAL</b>
DRAWN: JAZ	
CHKD: RF	
SCG PROJECT 21G166-2	
<b>PLATE 2</b>	

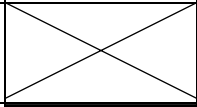
# BORING LOG LEGEND

SAMPLE TYPE	GRAPHICAL SYMBOL	SAMPLE DESCRIPTION
AUGER		SAMPLE COLLECTED FROM AUGER CUTTINGS, NO FIELD MEASUREMENT OF SOIL STRENGTH. (DISTURBED)
CORE		ROCK CORE SAMPLE: TYPICALLY TAKEN WITH A DIAMOND-TIPPED CORE BARREL. TYPICALLY USED ONLY IN HIGHLY CONSOLIDATED BEDROCK.
GRAB		SOIL SAMPLE TAKEN WITH NO SPECIALIZED EQUIPMENT, SUCH AS FROM A STOCKPILE OR THE GROUND SURFACE. (DISTURBED)
CS		CALIFORNIA SAMPLER: 2-1/2 INCH I.D. SPLIT BARREL SAMPLER, LINED WITH 1-INCH HIGH BRASS RINGS. DRIVEN WITH SPT HAMMER. (RELATIVELY UNDISTURBED)
NSR		NO RECOVERY: THE SAMPLING ATTEMPT DID NOT RESULT IN RECOVERY OF ANY SIGNIFICANT SOIL OR ROCK MATERIAL.
SPT		STANDARD PENETRATION TEST: SAMPLER IS A 1.4 INCH INSIDE DIAMETER SPLIT BARREL, DRIVEN 18 INCHES WITH THE SPT HAMMER. (DISTURBED)
SH		SHELBY TUBE: TAKEN WITH A THIN WALL SAMPLE TUBE, PUSHED INTO THE SOIL AND THEN EXTRACTED. (UNDISTURBED)
VANE		VANE SHEAR TEST: SOIL STRENGTH OBTAINED USING A 4 BLADED SHEAR DEVICE. TYPICALLY USED IN SOFT CLAYS-NO SAMPLE RECOVERED.

## COLUMN DESCRIPTIONS

### DEPTH:

Distance in feet below the ground surface.

### SAMPLE:

Sample Type as depicted above.

### BLOW COUNT:

Number of blows required to advance the sampler 12 inches using a 140 lb hammer with a 30-inch drop. 50/3" indicates penetration refusal (>50 blows) at 3 inches. WH indicates that the weight of the hammer was sufficient to push the sampler 6 inches or more.

### POCKET PEN.:

Approximate shear strength of a cohesive soil sample as measured by pocket penetrometer.

### GRAPHIC LOG:

Graphic Soil Symbol as depicted on the following page.

### DRY DENSITY:

Dry density of an undisturbed or relatively undisturbed sample in lbs/ft<sup>3</sup>.

### MOISTURE CONTENT:

Moisture content of a soil sample, expressed as a percentage of the dry weight.

### LIQUID LIMIT:

The moisture content above which a soil behaves as a liquid.

### PLASTIC LIMIT:

The moisture content above which a soil behaves as a plastic.

### PASSING #200 SIEVE:

The percentage of the sample finer than the #200 standard sieve.

### UNCONFINED SHEAR:

The shear strength of a cohesive soil sample, as measured in the unconfined state.

# SOIL CLASSIFICATION CHART

MAJOR DIVISIONS			SYMBOLS		TYPICAL DESCRIPTIONS	
			GRAPH	LETTER		
<p><b>COARSE GRAINED SOILS</b></p> <p>MORE THAN 50% OF MATERIAL IS LARGER THAN NO. 200 SIEVE SIZE</p>	<p><b>GRAVEL AND GRAVELLY SOILS</b></p>	<p>CLEAN GRAVELS</p> <p>(LITTLE OR NO FINES)</p>		<b>GW</b>	WELL-GRADED GRAVELS, GRAVEL - SAND MIXTURES, LITTLE OR NO FINES	
		<p>MORE THAN 50% OF COARSE FRACTION RETAINED ON NO. 4 SIEVE</p>	<p>GRAVELS WITH FINES</p> <p>(APPRECIABLE AMOUNT OF FINES)</p>		<b>GP</b>	POORLY-GRADED GRAVELS, GRAVEL - SAND MIXTURES, LITTLE OR NO FINES
			<p>GRAVELS WITH FINES</p> <p>(APPRECIABLE AMOUNT OF FINES)</p>		<b>GM</b>	SILTY GRAVELS, GRAVEL - SAND - SILT MIXTURES
		<p>MORE THAN 50% OF COARSE FRACTION PASSING ON NO. 4 SIEVE</p>	<p><b>SAND AND SANDY SOILS</b></p>	<p>CLEAN SANDS</p> <p>(LITTLE OR NO FINES)</p>		<b>SW</b>
	<p>SANDS WITH FINES</p> <p>(APPRECIABLE AMOUNT OF FINES)</p>				<b>SP</b>	POORLY-GRADED SANDS, GRAVELLY SAND, LITTLE OR NO FINES
	<p><b>FINE GRAINED SOILS</b></p> <p>MORE THAN 50% OF MATERIAL IS SMALLER THAN NO. 200 SIEVE SIZE</p>	<p><b>SILTS AND CLAYS</b></p> <p>LIQUID LIMIT LESS THAN 50</p>	<p>CLEAN SANDS</p> <p>(LITTLE OR NO FINES)</p>		<b>SM</b>	SILTY SANDS, SAND - SILT MIXTURES
			<p>SANDS WITH FINES</p> <p>(APPRECIABLE AMOUNT OF FINES)</p>		<b>SC</b>	CLAYEY SANDS, SAND - CLAY MIXTURES
			<p>SANDS WITH FINES</p> <p>(APPRECIABLE AMOUNT OF FINES)</p>		<b>ML</b>	INORGANIC SILTS AND VERY FINE SANDS, ROCK FLOUR, SILTY OR CLAYEY FINE SANDS OR CLAYEY SILTS WITH SLIGHT PLASTICITY
		<p><b>SILTS AND CLAYS</b></p> <p>LIQUID LIMIT GREATER THAN 50</p>	<p>SANDS WITH FINES</p> <p>(APPRECIABLE AMOUNT OF FINES)</p>		<b>CL</b>	INORGANIC CLAYS OF LOW TO MEDIUM PLASTICITY, GRAVELLY CLAYS, SANDY CLAYS, SILTY CLAYS, LEAN CLAYS
			<p>SANDS WITH FINES</p> <p>(APPRECIABLE AMOUNT OF FINES)</p>		<b>OL</b>	ORGANIC SILTS AND ORGANIC SILTY CLAYS OF LOW PLASTICITY
<p>SANDS WITH FINES</p> <p>(APPRECIABLE AMOUNT OF FINES)</p>				<b>MH</b>	INORGANIC SILTS, MICACEOUS OR DIATOMACEOUS FINE SAND OR SILTY SOILS	
<p><b>HIGHLY ORGANIC SOILS</b></p>	<p><b>SILTS AND CLAYS</b></p> <p>LIQUID LIMIT GREATER THAN 50</p>	<p>SANDS WITH FINES</p> <p>(APPRECIABLE AMOUNT OF FINES)</p>		<b>CH</b>	INORGANIC CLAYS OF HIGH PLASTICITY	
		<p>SANDS WITH FINES</p> <p>(APPRECIABLE AMOUNT OF FINES)</p>		<b>OH</b>	ORGANIC CLAYS OF MEDIUM TO HIGH PLASTICITY, ORGANIC SILTS	
<p><b>HIGHLY ORGANIC SOILS</b></p>				<b>PT</b>	PEAT, HUMUS, SWAMP SOILS WITH HIGH ORGANIC CONTENTS	

NOTE: DUAL SYMBOLS ARE USED TO INDICATE BORDERLINE SOIL CLASSIFICATIONS





JOB NO.: 21G166-2      DRILLING DATE: 5/18/21      WATER DEPTH: ---  
 PROJECT: Proposed Gateway South Building 8      DRILLING METHOD: Hollow Stem Auger      CAVE DEPTH: ---  
 LOCATION: San Bernardino, California      LOGGED BY: Jamie Hayward      READING TAKEN: ---

FIELD RESULTS				DESCRIPTION	LABORATORY RESULTS						COMMENTS
DEPTH (FEET)	SAMPLE	BLOW COUNT	POCKET PEN. (TSF)		GRAPHIC LOG	DRY DENSITY (PCF)	MOISTURE CONTENT (%)	LIQUID LIMIT	PLASTIC LIMIT	PASSING #200 SIEVE (%)	
SURFACE ELEVATION: --- MSL											
		10			ALLUVIUM: Gray Brown fine Sandy Silt, little Iron oxide staining, little Calcareous nodules/veining, slightly porous, medium dense-moist		16				
		9			Gray Brown Silty fine Sand, trace medium to coarse Sand, little Iron oxide staining, loose-dry to very moist		6				
5		7					2				
		11			Dark Gray Brown Silty fine to coarse Sand, little Iron oxide staining, medium dense-very moist		17				
10		9			Gray Brown fine Sandy Silt, trace medium to coarse Sand, little Iron oxide staining, 2-inch fine Sand lense, loose-very moist		15				
							24				
Boring Terminated at 12'											

TBL\_21G166-2.GPJ\_SOCALGEO.GDT 6/9/21



JOB NO.: 21G166-2	DRILLING DATE: 5/18/21	WATER DEPTH: ---
PROJECT: Proposed Gateway South Building 8	DRILLING METHOD: Hollow Stem Auger	CAVE DEPTH: ---
LOCATION: San Bernardino, California	LOGGED BY: Jamie Hayward	READING TAKEN: ---

FIELD RESULTS				DESCRIPTION	LABORATORY RESULTS						COMMENTS
DEPTH (FEET)	SAMPLE	BLOW COUNT	POCKET PEN. (TSF)		GRAPHIC LOG	DRY DENSITY (PCF)	MOISTURE CONTENT (%)	LIQUID LIMIT	PLASTIC LIMIT	PASSING #200 SIEVE (%)	
SURFACE ELEVATION: --- MSL											
14				ALLUVIUM: Gray Brown fine Sand, little Silt, loose to medium dense-damp to moist		3					
7				@ 3½ feet, 3-inch Silty fine Sand lense		11					
5				Gray Brown Silty fine to medium Sand, little coarse Sand, little Iron oxide staining, loose-moist		12					
8				@ 8½ feet, 3-inch fine Sandy Silt lense with Iron oxide staining		7					
9				Gray Brown Gravelly fine to medium Sand, some Silt, little coarse Sand, dense-moist		9					
10											
46											
Boring Terminated at 12'											

TBL 21G166-2.GPJ\_SOCALGEO.GDT 6/9/21



JOB NO.: 21G166-2	DRILLING DATE: 5/18/21	WATER DEPTH: ---
PROJECT: Proposed Gateway South Building 8	DRILLING METHOD: Hollow Stem Auger	CAVE DEPTH: ---
LOCATION: San Bernardino, California	LOGGED BY: Jamie Hayward	READING TAKEN: ---

FIELD RESULTS				DESCRIPTION	LABORATORY RESULTS						COMMENTS
DEPTH (FEET)	SAMPLE	BLOW COUNT	POCKET PEN. (TSF)		GRAPHIC LOG	DRY DENSITY (PCF)	MOISTURE CONTENT (%)	LIQUID LIMIT	PLASTIC LIMIT	PASSING #200 SIEVE (%)	
SURFACE ELEVATION: --- MSL											
	X	4			<p><u>ALLUVIUM:</u> Light Gray Brown Silty fine Sand, trace medium to coarse Sand, trace fine Gravel, little fine root fibers, very loose to loose-damp</p> <hr/> <p>Light Gray Brown fine Sand, little Silt, trace fine root fibers, loose-damp</p> <hr/> <p>Gray Brown Silty fine to medium Sand, little Iron oxide staining, medium dense-damp</p> <hr/> <p>@ 10½ feet, 2-inch lense Silty fine Sand</p>	3					
5	X	2				3					
10	X	8				4					
11	X	11				7					
					6						
Boring Terminated at 12'											

TBL 21G166-2.GPJ\_SOCALGEO.GDT 6/9/21



JOB NO.: 21G166-2      DRILLING DATE: 5/18/21      WATER DEPTH: ---  
 PROJECT: Proposed Gateway South Building 8      DRILLING METHOD: Hollow Stem Auger      CAVE DEPTH: ---  
 LOCATION: San Bernardino, California      LOGGED BY: Jamie Hayward      READING TAKEN: ---

FIELD RESULTS				DESCRIPTION	LABORATORY RESULTS						COMMENTS	
DEPTH (FEET)	SAMPLE	BLOW COUNT	POCKET PEN. (TSF)		GRAPHIC LOG	DRY DENSITY (PCF)	MOISTURE CONTENT (%)	LIQUID LIMIT	PLASTIC LIMIT	PASSING #200 SIEVE (%)		ORGANIC CONTENT (%)
SURFACE ELEVATION: --- MSL												
		22		[Symbol]	<u>FILL:</u> Gray Brown Silty fine Sand, little Iron oxide staining, loose to medium dense-very moist		18					
		7		[Symbol]			18					
5				[Symbol]	<u>FILL:</u> Light Gray fine Sand, trace Silt, little Iron oxide staining, loose to medium dense-damp		9					
		10		[Symbol]	@ 6 feet, little Brick fragments		6					
				[Symbol]	<u>FILL:</u> Orange Brown fine Sand, loose-very moist		16					
10				[Symbol]	<u>FILL:</u> Gray Brown Silty fine Sand, little Iron oxide staining, loose-damp to moist							
				[Symbol]								
15		36		[Symbol]	@ 13½ feet, little Brick fragments, dense		9					
				[Symbol]								
20		54		[Symbol]	<u>ALLUVIUM:</u> Gray Gravelly fine to coarse Sand, little Silt, very dense-dry to damp		2					
				[Symbol]								
				[Symbol]	Boring Terminated at 20'							

TBL 21G166-2.GPJ\_SOCALGEO.GDT 6/9/21

# INFILTRATION CALCULATIONS

Project Name	Proposed Gateway South Building 8
Project Location	San Bernardino, California
Project Number	21G166-2
Engineer	Ryan Bremer

Test Hole Radius	4 (in)
Test Depth	12.00 (ft)

Infiltration Test Hole	I-1
------------------------	-----

Soil Criteria Test							
Interval Number		Time	Time Interval (min)	Water Depth (ft)	Change in Water Level (in)	Did 6 inches of water seep away in less than 25 minutes?	Sandy Soils or Non-Sandy Soils?
1	Initial	7:01 AM	25.00	9.80	18.84	YES	SANDY SOILS
	Final	7:26 AM		11.37			
2	Initial	7:26 AM	25.00	9.80	16.92	YES	SANDY SOILS
	Final	7:51 AM		11.21			

Test Data							
Interval Number		Time	Time Interval (min)	Water Depth (ft)	Change in Water Level (ft)	Average Head Height (ft)	Infiltration Rate Q (in/hr)
1	Initial	7:52 AM	10.00	9.90	0.79	1.71	5.07
	Final	8:02 AM		10.69			
2	Initial	8:02 AM	10.00	10.03	0.62	1.66	4.07
	Final	8:12 AM		10.65			
3	Initial	8:12 AM	10.00	9.85	0.63	1.84	3.78
	Final	8:22 AM		10.48			
4	Initial	8:22 AM	10.00	9.90	0.60	1.80	3.66
	Final	8:32 AM		10.50			
5	Initial	8:32 AM	10.00	9.85	0.57	1.87	3.37
	Final	8:42 AM		10.42			
6	Initial	8:42 AM	10.00	9.90	0.48	1.86	2.84
	Final	8:52 AM		10.38			

Per County Standards, Infiltration Rate calculated as follows:

Where:

$$Q = \frac{\Delta H(60r)}{\Delta t(r + 2H_{avg})}$$

- Q = Infiltration Rate (in inches per hour)
- ΔH = Change in Height (Water Level) over the time interval
- r = Test Hole (Borehole) Radius
- Δt = Time Interval
- H<sub>avg</sub> = Average Head Height over the time interval

**INFILTRATION CALCULATIONS**

Project Name	Proposed Gateway South Building 8
Project Location	San Bernardino, California
Project Number	21G166-2
Engineer	Ryan Bremer

Test Hole Radius	4 (in)
Test Depth	12.00 (ft)

Infiltration Test Hole	I-2
------------------------	-----

Soil Criteria Test							
Interval Number		Time	Time Interval (min)	Water Depth (ft)	Change in Water Level (in)	Did 6 inches of water seep away in less than 25 minutes?	Sandy Soils or Non-Sandy Soils?
1	Initial	8:58 AM	25.00	9.00	36.00	YES	SANDY SOILS
	Final	9:23 AM		12.00			
2	Initial	9:23 AM	25.00	8.50	42.00	YES	SANDY SOILS
	Final	9:48 AM		12.00			

Test Data							
Interval Number		Time	Time Interval (min)	Water Depth (ft)	Change in Water Level (ft)	Average Head Height (ft)	Infiltration Rate Q (in/hr)
1	Initial	9:48 AM	10.00	9.35	1.85	1.73	11.74
	Final	9:58 AM		11.20			
2	Initial	9:58 AM	10.00	9.30	2.17	1.62	14.62
	Final	10:08 AM		11.47			
3	Initial	10:08 AM	10.00	9.35	2.19	1.56	15.26
	Final	10:18 AM		11.54			
4	Initial	10:18 AM	10.00	9.30	2.17	1.62	14.62
	Final	10:28 AM		11.47			
5	Initial	10:28 AM	10.00	9.32	2.10	1.63	14.03
	Final	10:38 AM		11.42			
6	Initial	10:38 AM	10.00	9.35	1.99	1.66	13.11
	Final	10:48 AM		11.34			

Per County Standards, Infiltration Rate calculated as follows:

Where:

$$Q = \frac{\Delta H(60r)}{\Delta t(r + 2H_{avg})}$$

- Q = Infiltration Rate (in inches per hour)
- ΔH = Change in Height (Water Level) over the time interval
- r = Test Hole (Borehole) Radius
- Δt = Time Interval
- H<sub>avg</sub> = Average Head Height over the time interval

## INFILTRATION CALCULATIONS

Project Name	Proposed Gateway South Building 8
Project Location	San Bernardino, California
Project Number	21G166-2
Engineer	Ryan Bremer

Test Hole Radius	4 (in)
Test Depth	12.00 (ft)

Infiltration Test Hole	I-3
------------------------	-----

Soil Criteria Test							
Interval Number		Time	Time Interval (min)	Water Depth (ft)	Change in Water Level (in)	Did 6 inches of water seep away in less than 25 minutes?	Sandy Soils or Non-Sandy Soils?
1	Initial	10:55 AM	25.00	8.80	18.00	YES	SANDY SOILS
	Final	11:20 AM		10.30			
2	Initial	11:20 AM	25.00	8.85	20.04	YES	SANDY SOILS
	Final	11:45 AM		10.52			

Test Data							
Interval Number		Time	Time Interval (min)	Water Depth (ft)	Change in Water Level (ft)	Average Head Height (ft)	Infiltration Rate Q (in/hr)
1	Initial	11:46 AM	10.00	9.91	0.26	1.96	1.47
	Final	11:56 AM		10.17			
2	Initial	11:56 AM	10.00	9.90	0.29	1.96	1.64
	Final	12:06 PM		10.19			
3	Initial	12:06 PM	10.00	9.91	0.26	1.96	1.47
	Final	12:16 PM		10.17			
4	Initial	12:16 PM	10.00	9.91	0.23	1.98	1.29
	Final	12:26 PM		10.14			
5	Initial	12:26 PM	10.00	9.91	0.22	1.98	1.23
	Final	12:36 PM		10.13			
6	Initial	12:36 PM	10.00	9.95	0.17	1.97	0.96
	Final	12:46 PM		10.12			

Per County Standards, Infiltration Rate calculated as follows:

Where:

$$Q = \frac{\Delta H(60r)}{\Delta t(r + 2H_{avg})}$$

- Q = Infiltration Rate (in inches per hour)
- $\Delta H$  = Change in Height (Water Level) over the time interval
- r = Test Hole (Borehole) Radius
- $\Delta t$  = Time Interval
- $H_{avg}$  = Average Head Height over the time interval

# INFILTRATION CALCULATIONS

Project Name	Proposed Gateway South Building 8
Project Location	San Bernardino, California
Project Number	21G166-2
Engineer	Ryan Bremer

Test Hole Radius	4 (in)
Test Depth	19.00 (ft)

Infiltration Test Hole I-4

Soil Criteria Test							
Interval Number		Time	Time Interval (min)	Water Depth (ft)	Change in Water Level (in)	Did 6 inches of water seep away in less than 25 minutes?	Sandy Soils or Non-Sandy Soils?
1	Initial	1:03 PM	25.00	16.50	30.00	YES	SANDY SOILS
	Final	1:28 PM		19.00			
2	Initial	1:28 PM	25.00	16.50	30.00	YES	SANDY SOILS
	Final	1:53 PM		19.00			

Test Data							
Interval Number		Time	Time Interval (min)	Water Depth (ft)	Change in Water Level (ft)	Average Head Height (ft)	Infiltration Rate Q (in/hr)
1	Initial	1:54 PM	10.00	17.00	2.00	1.00	20.57
	Final	2:04 PM		19.00			
2	Initial	2:04 PM	10.00	17.00	1.97	1.02	20.01
	Final	2:14 PM		18.97			
3	Initial	2:14 PM	10.00	17.00	1.97	1.02	20.01
	Final	2:24 PM		18.97			
4	Initial	2:24 PM	10.00	17.00	1.97	1.02	20.01
	Final	2:34 PM		18.97			
5	Initial	2:34 PM	10.00	17.00	1.97	1.02	20.01
	Final	2:44 PM		18.97			
6	Initial	2:44 PM	10.00	17.00	1.97	1.02	20.01
	Final	2:54 PM		18.97			

Per County Standards, Infiltration Rate calculated as follows:

Where:

$$Q = \frac{\Delta H(60r)}{\Delta t(r + 2H_{avg})}$$

- Q = Infiltration Rate (in inches per hour)
- ΔH = Change in Height (Water Level) over the time interval
- r = Test Hole (Borehole) Radius
- Δt = Time Interval
- H<sub>avg</sub> = Average Head Height over the time interval



# Grain Size Distribution

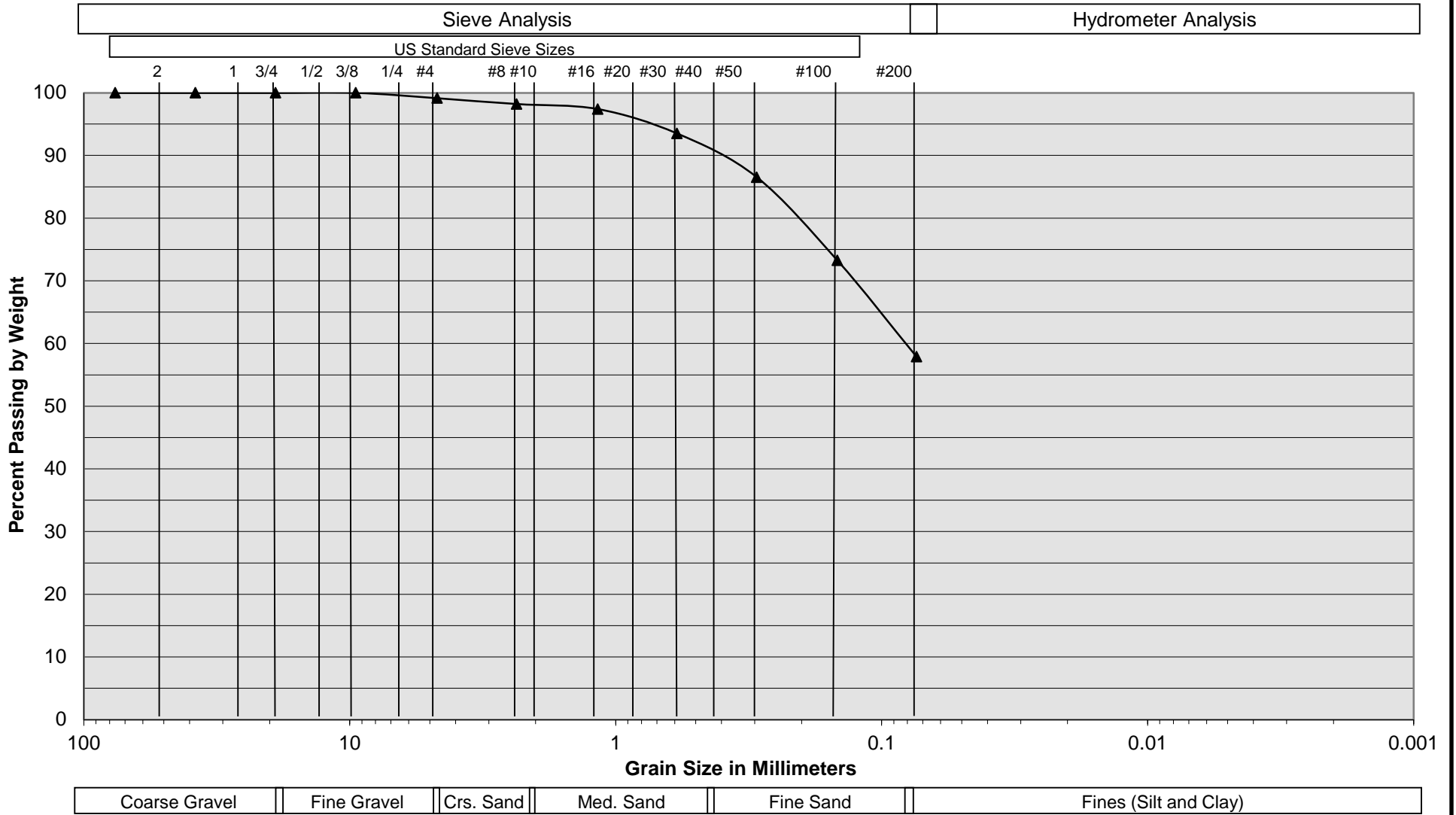

# Grain Size Distribution

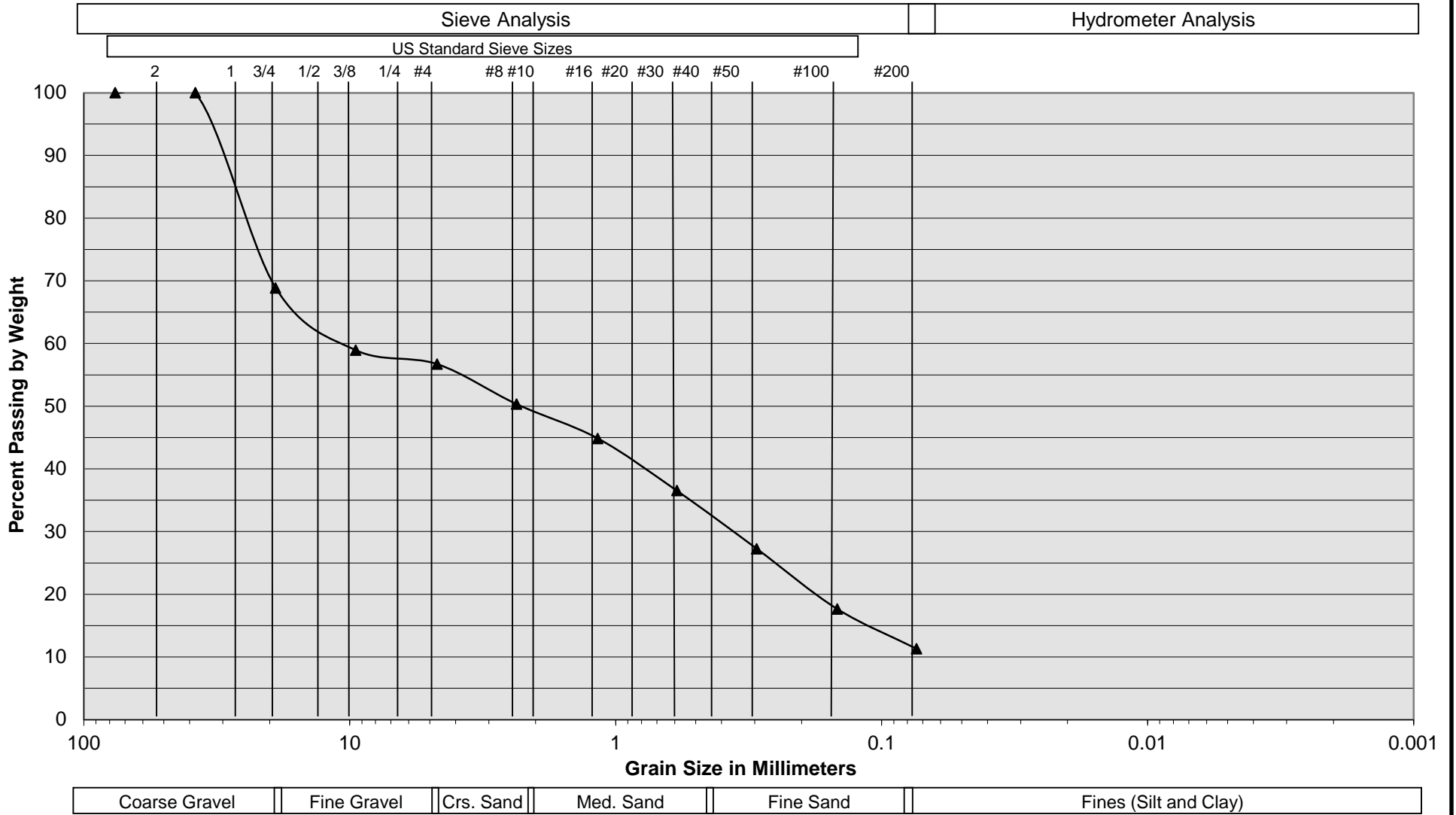

Sample Description	I-2 @ 10½'
Soil Classification	Gray Brown Gravelly fine to medium Sand, some Silt, little coarse Sand

Proposed Gateway South Building 8  
 San Bernardino, California  
 Project No. 21G166-2  
**PLATE C- 2**



**SOUTHERN CALIFORNIA GEOTECHNICAL**  
A California Corporation

# Grain Size Distribution

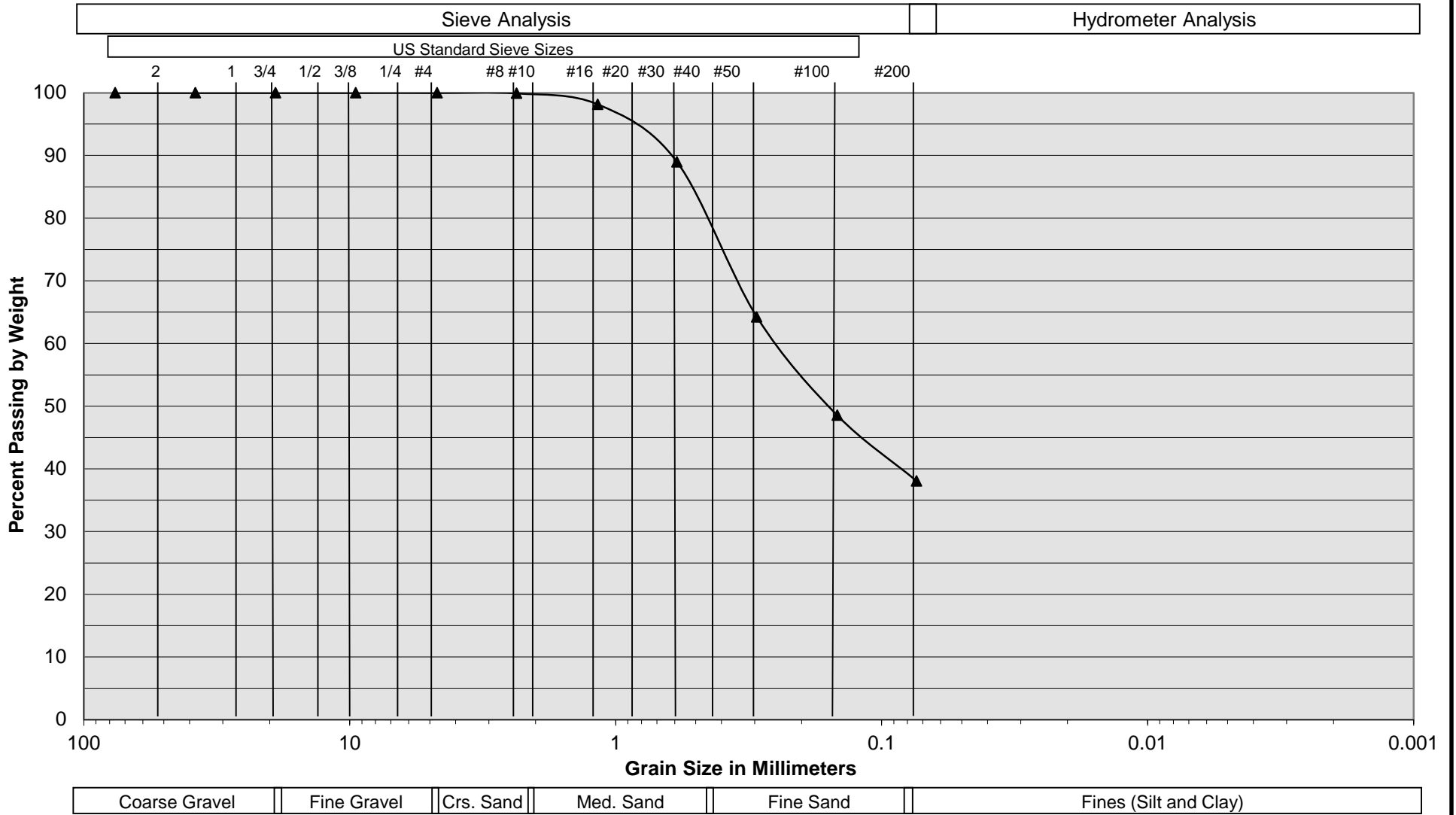

# Grain Size Distribution

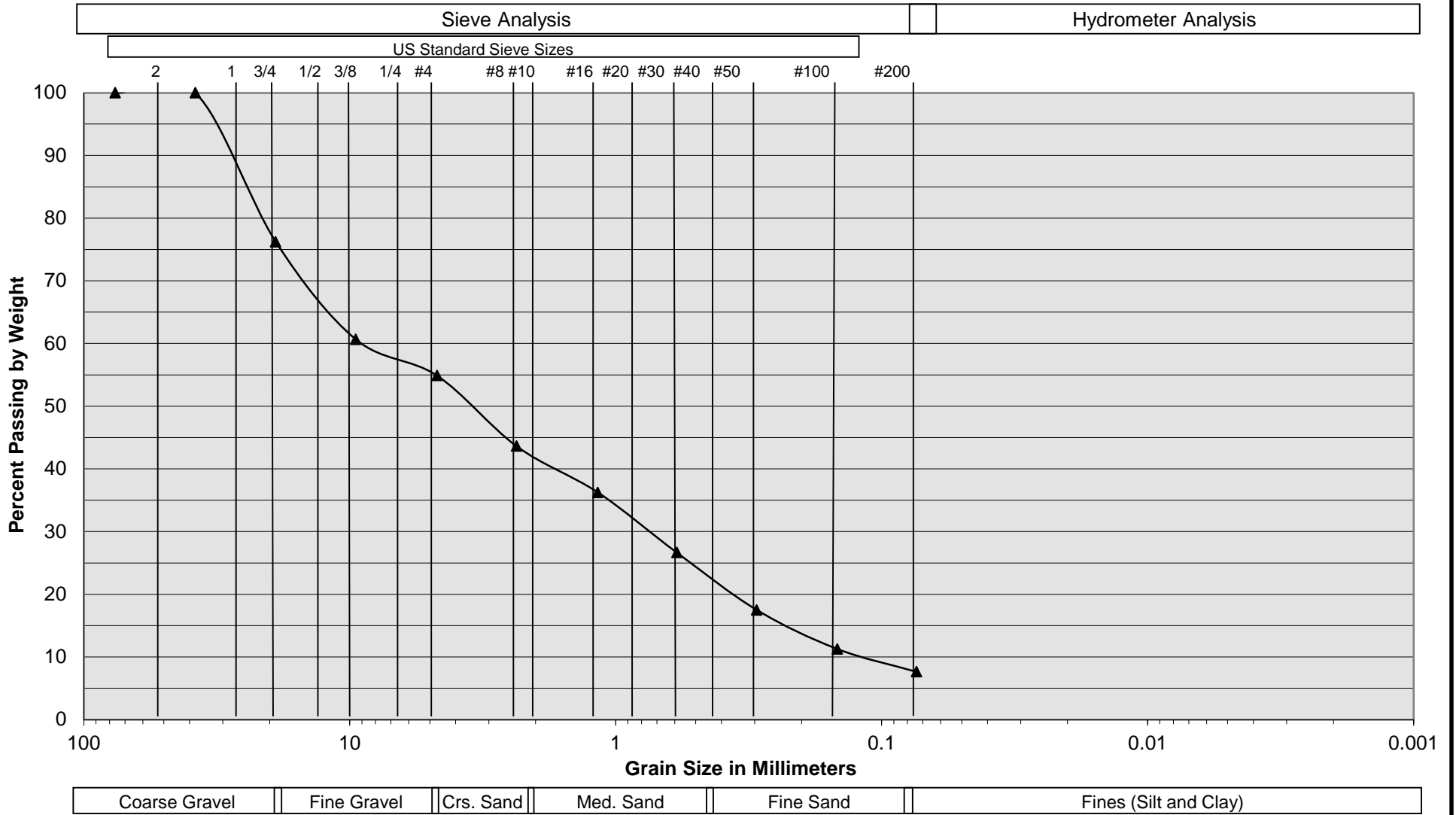

Sample Description	I-4 @ 18.5'
Soil Classification	Gray Gravelly fine to coarse Sand, little Silt

Proposed Gateway South Building 8  
 San Bernardino, California  
 Project No. 21G166-2  
**PLATE C- 4**



**SOUTHERN CALIFORNIA GEOTECHNICAL**  
A California Corporation

**Attachment G**  
**BMP O&M**



**SAMPLE STENCIL TO BE USED NEAR  
GRATE AND CURB OPENING INLETS**



**Thienes Engineering**

CIVIL ENGINEERING • LAND SURVEYING  
14349 FIRESTONE BOULEVARD  
LA MIRADA, CALIFORNIA 90638  
PH (714) 521-4811 FAX (714) 521-4173

**SAMPLE CATCH BASIN STENCIL  
PER BMP SD-13**

## Hydra Connector Pipe Screen (CPS) Operation & Maintenance (O&M)

### Note

CPS devices should be maintained by individuals who are trained in proper disposal procedures, confined space entry and traffic safety regulations. When servicing a Hydra CPS device be sure to follow all safety and traffic control protocols as well as wearing all proper personal protection equipment such as gloves, safety glasses, hard-hat, safety vest and work boots.

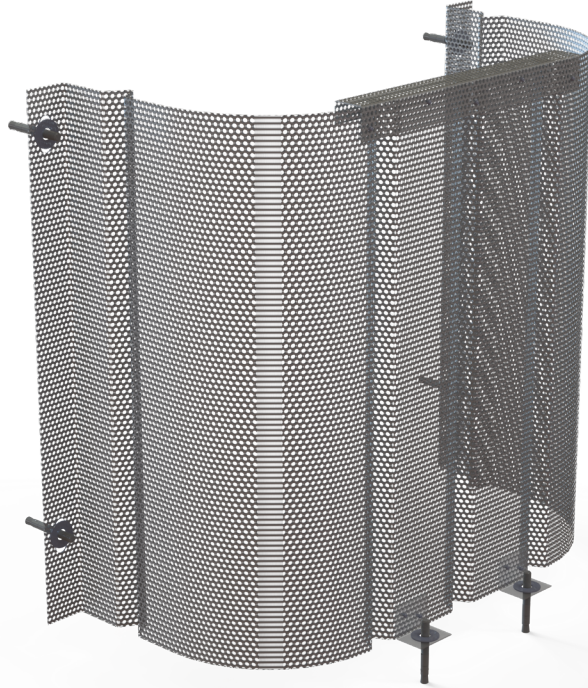

### Visual Inspection

1. Begin by inspecting the inflow of the catch basin where the Hydra CPS device is located. Check for any obstructions to inflow of the CB unit. If any large obstructions are found, have them removed. Once the inflow inspection is completed, remove the man-hole cover for further inspection. (Note: Confined Space Entry Procedures may apply if trained personnel intend to enter the interior space of any Catch Basin. Please follow all applicable confined space entry procedures)
2. Remove the manhole cover and visually estimate the amount and types of debris found in the CB unit. Look for any visual signs of damage that may compromise the CB unit to function properly. Inspect for any standing water in the CB unit as well as for large amounts of sediment and debris surrounding the CPS device. If standing water and high sediment volume is found, remove water, sediment and debris by vacuum truck or by other debris removal methods.

### Cleaning Procedures and Frequencies

1. Like all other storm water BMP's, Hydra CPS devices require periodic maintenance.



A Forterra Company

Routine inspection and maintenance intervals for all CPS devices are typically twice per year for inspections and once per year for maintenance service. Hydra CPS devices may require more frequent maintenance service if the device is located in a high debris loading drainage area, such as certain downtown areas, retail/restaurant, or residential areas where a significant amount of vegetation/foilage is located. In such cases, Modular CPS devices may require more frequent inspection and maintenance service, which could range from twice per year to monthly inspection and maintenance service, depending on pollutant load conditions.

2. To begin Hydra CPS cleaning procedures, conduct a visual inspection of the CPS device and the surrounding area to ensure a safe working environment. Setup appropriate barriers and signage as necessary to establish a work zone surrounding the catch basin. Once the work zone has been established, remove the manhole cover from the catch basin.
3. Once the manhole cover is removed from the basin the Modular CPS is ready for servicing. All debris can be removed by either a vacuum truck or manually removing sediment and debris by hand.
4. Hydra CPS devices shall be cleaned using a pressure washer as may be necessary if any materials are found to cause occlusion or clogging of the screen.

### Disposal

1. All trash and debris removed from the Hydra CPS unit shall be disposed of in accordance with local, state and federal regulation.
2. Solid waste disposal can be coordinated with local landfills. Liquids may need to be disposed of by wastewater treatment plant, municipal vacuum truck decant facility or approved facility.

**For maintenance services please contact Bio Clean at:**

**760-433-7640**

[info@biocleanenvironmental.com](mailto:info@biocleanenvironmental.com)



## CDS<sup>®</sup> Inspection and Maintenance Guide

---





## Maintenance

The CDS system should be inspected at regular intervals and maintained when necessary to ensure optimum performance. The rate at which the system collects pollutants will depend more heavily on site activities than the size of the unit. For example, unstable soils or heavy winter sanding will cause the grit chamber to fill more quickly but regular sweeping of paved surfaces will slow accumulation.

## Inspection

Inspection is the key to effective maintenance and is easily performed. Pollutant transport and deposition may vary from year to year and regular inspections will help ensure that the system is cleaned out at the appropriate time. At a minimum, inspections should be performed twice per year (e.g. spring and fall) however more frequent inspections may be necessary in climates where winter sanding operations may lead to rapid accumulations, or in equipment washdown areas. Installations should also be inspected more frequently where excessive amounts of trash are expected.

The visual inspection should ascertain that the system components are in working order and that there are no blockages or obstructions in the inlet and separation screen. The inspection should also quantify the accumulation of hydrocarbons, trash, and sediment in the system. Measuring pollutant accumulation can be done with a calibrated dipstick, tape measure or other measuring instrument. If absorbent material is used for enhanced removal of hydrocarbons, the level of discoloration of the sorbent material should also be identified during inspection. It is useful and often required as part of an operating permit to keep a record of each inspection. A simple form for doing so is provided.

Access to the CDS unit is typically achieved through two manhole access covers. One opening allows for inspection and cleanout of the separation chamber (cylinder and screen) and isolated sump. The other allows for inspection and cleanout of sediment captured and retained outside the screen. For deep units, a single manhole access point would allow both sump cleanout and access outside the screen.

The CDS system should be cleaned when the level of sediment has reached 75% of capacity in the isolated sump or when an appreciable level of hydrocarbons and trash has accumulated. If absorbent material is used, it should be replaced when significant discoloration has occurred. Performance will not be impacted until 100% of the sump capacity is exceeded however it is recommended that the system be cleaned prior to that for easier removal of sediment. The level of sediment is easily determined by measuring from finished grade down to the top of the sediment pile. To avoid underestimating the level of sediment in the chamber, the measuring device must be lowered to the top of the sediment pile carefully. Particles at the top of the pile typically offer less resistance to the end of the rod than consolidated particles toward the bottom of the pile. Once this measurement is recorded, it should be compared to the as-built drawing for the unit to determine whether the height of the sediment pile off the bottom of the sump floor exceeds 75% of the total height of isolated sump.

## Cleaning

Cleaning of a CDS system should be done during dry weather conditions when no flow is entering the system. The use of a vacuum truck is generally the most effective and convenient method of removing pollutants from the system. Simply remove the manhole covers and insert the vacuum hose into the sump. The system should be completely drained down and the sump fully evacuated of sediment. The area outside the screen should also be cleaned out if pollutant build-up exists in this area.

In installations where the risk of petroleum spills is small, liquid contaminants may not accumulate as quickly as sediment. However, the system should be cleaned out immediately in the event of an oil or gasoline spill should be cleaned out immediately. Motor oil and other hydrocarbons that accumulate on a more routine basis should be removed when an appreciable layer has been captured. To remove these pollutants, it may be preferable to use absorbent pads since they are usually less expensive to dispose than the oil/water emulsion that may be created by vacuuming the oily layer. Trash and debris can be netted out to separate it from the other pollutants. The screen should be power washed to ensure it is free of trash and debris.

Manhole covers should be securely seated following cleaning activities to prevent leakage of runoff into the system from above and also to ensure that proper safety precautions have been followed. Confined space entry procedures need to be followed if physical access is required. Disposal of all material removed from the CDS system should be done in accordance with local regulations. In many jurisdictions, disposal of the sediments may be handled in the same manner as the disposal of sediments removed from catch basins or deep sump manholes.



CDS Model	Diameter		Distance from Water Surface to Top of Sediment Pile		Sediment Storage Capacity	
	ft	m	ft	m	yd3	m3
CDS2015-4	4	1.2	3.0	0.9	0.5	0.4
CDS2015	5	1.5	3.0	0.9	1.3	1.0
CDS2020	5	1.5	3.5	1.1	1.3	1.0
CDS2025	5	1.5	4.0	1.2	1.3	1.0
CDS3020	6	1.8	4.0	1.2	2.1	1.6
CDS3030	6	1.8	4.6	1.4	2.1	1.6
CDS3035	6	1.8	5.0	1.5	2.1	1.6
CDS4030	8	2.4	4.6	1.4	5.6	4.3
CDS4040	8	2.4	5.7	1.7	5.6	4.3
CDS4045	8	2.4	6.2	1.9	5.6	4.3

Table 1: CDS Maintenance Indicators and Sediment Storage Capacities



#### Support

- Drawings and specifications are available at [www.contechstormwater.com](http://www.contechstormwater.com).
- Site-specific design support is available from our engineers.

©2014 Contech Engineered Solutions LLC

Contech Engineered Solutions LLC provides site solutions for the civil engineering industry. Contech's portfolio includes bridges, drainage, sanitary sewer, stormwater, earth stabilization and wastewater treatment products. For information, visit [www.ContechES.com](http://www.ContechES.com) or call 800.338.1122

NOTHING IN THIS CATALOG SHOULD BE CONSTRUED AS AN EXPRESSED WARRANTY OR AN IMPLIED WARRANTY OF MERCHANTABILITY OR FITNESS FOR ANY PARTICULAR PURPOSE. SEE THE CONTECH STANDARD CONDITION OF SALES (VIEWABLE AT [WWW.CONTECHES.COM/COS](http://WWW.CONTECHES.COM/COS)) FOR MORE INFORMATION.

The product(s) described may be protected by one or more of the following US patents: 5,322,629; 5,624,576; 5,707,527; 5,759,415; 5,788,848; 5,985,157; 6,027,639; 6,350,374; 6,406,218; 6,641,720; 6,511,595; 6,649,048; 6,991,114; 6,998,038; 7,186,058; 7,296,692; 7,297,266; 7,517,450 related foreign patents or other patents pending.





# STORMTECH MC-3500 CHAMBER

Designed to meet the most stringent industry performance standards for superior structural integrity while providing designers with a cost-effective method to save valuable land and protect water resources. The StormTech system is designed primarily to be used under parking lots, thus maximizing land usage for private (commercial) and public applications. StormTech chambers can also be used in conjunction with Green Infrastructure, thus enhancing the performance and extending the service life of these practices.

## STORMTECH MC-3500 CHAMBER (not to scale)

### Nominal Chamber Specifications

**Size (L x W x H)**  
90" x 77" x 45"  
2,286 mm x 1,956 mm x 1,143 mm

**Chamber Storage**  
109.9 ft<sup>3</sup> (3.11 m<sup>3</sup>)

**Min. Installed Storage\***  
175.0 ft<sup>3</sup> (4.96 m<sup>3</sup>)

**Weight**  
134 lbs (60.8 kg)

**Shipping**  
15 chambers/pallet  
7 end caps/pallet  
7 pallets/truck

\*Assumes a minimum of 12" (300 mm) of stone above, 9" (230 mm) of stone below chambers, 6" (150 mm) of stone between chambers/end caps and 40% stone porosity.

## STORMTECH MC-3500 END CAP (not to scale)

### Nominal End Cap Specifications

**Size (L x W x H)**  
26.5" x 71" x 45.1"  
673 mm x 1,803 mm x 1,145 mm

**End Cap Storage**  
14.9 ft<sup>3</sup> (0.42 m<sup>3</sup>)

**Min. Installed Storage\***  
45.1 ft<sup>3</sup> (1.28 m<sup>3</sup>)

**Weight**  
49 lbs (22.2 kg)

\*Assumes a minimum of 12" (300 mm) of stone above, 9" (230 mm) of stone below, 6" (150 mm) of stone between chambers, 6" (150 mm) of stone between chambers/end caps and 40% stone porosity.

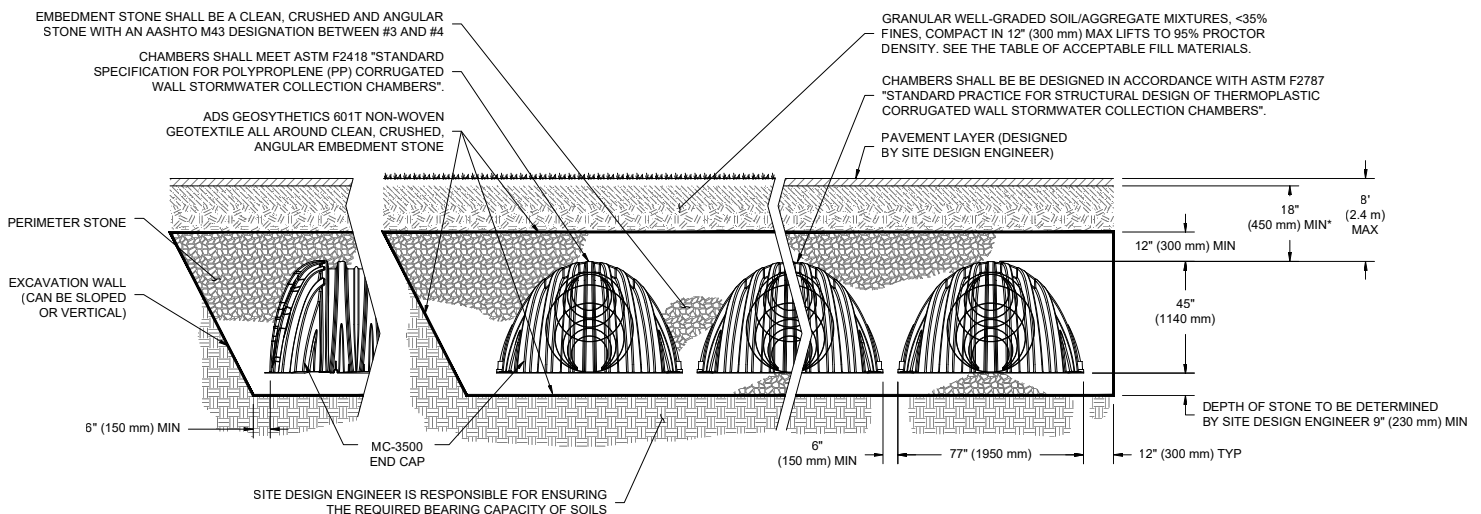
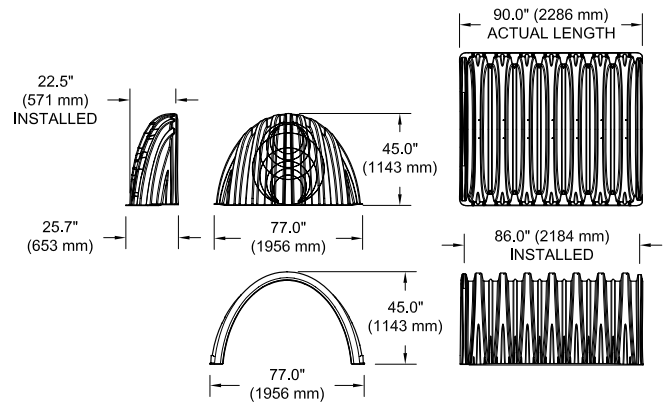

\*MINIMUM COVER TO BOTTOM OF FLEXIBLE PAVEMENT. FOR UNPAVED INSTALLATIONS WHERE RUTTING FROM VEHICLES MAY OCCUR, INCREASE COVER TO 24" (600 mm).

## MC-3500 CHAMBER SPECIFICATION

### STORAGE VOLUME PER CHAMBER FT<sup>3</sup> (M<sup>3</sup>)

	Bare Chamber Storage ft <sup>3</sup> (m <sup>3</sup> )	Chamber and Stone Foundation Depth in. (mm)			
		9" (230 mm)	12" (300 mm)	15" (375 mm)	18" (450 mm)
MC-3500 Chamber	109.9 (3.11)	175.0 (4.96)	179.9 (5.09)	184.9 (5.24)	189.9 (5.38)
MC-3500 End Cap	14.9 (.42)	45.1 (1.28)	46.6 (1.32)	48.3 (1.37)	49.9 (1.41)

**Note:** Assumes 6" (150 mm) row spacing, 40% stone porosity, 12" (300 mm) stone above and includes the bare chamber/end cap volume.

### AMOUNT OF STONE PER CHAMBER

ENGLISH TONS (yds <sup>3</sup> )	Stone Foundation Depth			
	9"	12"	15"	18"
MC-3500 Chamber	8.5 (6.0)	9.1 (6.5)	9.7 (6.9)	10.4 (7.4)
MC-3500 End Cap	3.9 (2.8)	4.1 (2.9)	4.3 (3.1)	4.5 (3.2)
METRIC KILOGRAMS (m <sup>3</sup> )	230 mm	300 mm	375 mm	450 mm
MC-3500 Chamber	7711 (4.6)	8255 (5.0)	8800 (5.3)	9435 (5.7)
MC-3500 End Cap	3538 (2.1)	3719 (2.2)	3901 (2.4)	4082 (2.5)

**Note:** Assumes 12" (300 mm) of stone above and 6" (150 mm) row spacing and 6" (150 mm) of perimeter stone in front of end caps.

### VOLUME EXCAVATION PER CHAMBER YD<sup>3</sup> (M<sup>3</sup>)

	Stone Foundation Depth			
	9" (230 mm)	12" (300 mm)	15" (375mm)	18" (450 mm)
MC-3500 Chamber	11.9 (9.1)	12.4 (9.5)	12.8(9.8)	13.3 (10.2)
MC-3500 End Cap	4.0 (3.1)	4.1 (3.2)	4.3 (3.3)	4.4 (3.4)

**Note:** Assumes 6" (150 mm) of separation between chamber rows and 24" (600 mm) of cover. The volume of excavation will vary as depth of cover increases.



**Working on a project?**  
 Visit us at [www.stormtech.com](http://www.stormtech.com)  
 and utilize the **StormTech Design Tool**

For more information on the StormTech MC-3500 Chamber and other ADS products, please contact our Customer Service Representatives at 1-800-821-6710



# Isolator<sup>®</sup> Row O&M Manual





## THE ISOLATOR<sup>®</sup> ROW

### INTRODUCTION

An important component of any Stormwater Pollution Prevention Plan is inspection and maintenance. The StormTech Isolator Row is a technique to inexpensively enhance Total Suspended Solids (TSS) removal and provide easy access for inspection and maintenance.

### THE ISOLATOR ROW

The Isolator Row is a row of StormTech chambers, either SC-160LP, SC-310, SC-310-3, SC-740, DC-780, MC-3500 or MC-4500 models, that is surrounded with filter fabric and connected to a closely located manhole for easy access. The fabric-wrapped chambers provide for settling and filtration of sediment as storm water rises in the Isolator Row and ultimately passes through the filter fabric. The open bottom chambers and perforated sidewalls (SC-310, SC-310-3 and SC-740 models) allow storm water to flow both vertically and horizontally out of the chambers. Sediments are captured in the Isolator Row protecting the storage areas of the adjacent stone and chambers from sediment accumulation.

Two different fabrics are used for the Isolator Row. A woven geotextile fabric is placed between the stone and the Isolator Row chambers. The tough geotextile provides a media for storm water filtration and provides a durable surface for maintenance operations. It is also designed to prevent scour of the underlying stone and remain intact during high pressure jetting. A non-woven fabric is placed over the chambers to provide a filter media for flows passing through the perforations in the sidewall of the chamber. The non-woven fabric is not required over the SC-160LP, DC-780, MC-3500 or MC-4500 models as these chambers do not have perforated side walls.

The Isolator Row is typically designed to capture the “first flush” and offers the versatility to be sized on a volume basis or flow rate basis. An upstream manhole not only provides access to the Isolator Row but typically includes a high flow weir such that storm water flowrates or volumes that exceed the capacity of the Isolator Row overtop the overflow weir and discharge through a manifold to the other chambers.

The Isolator Row may also be part of a treatment train. By treating storm water prior to entry into the chamber system, the service life can be extended and pollutants such as hydrocarbons can be captured. Pre-treatment best management practices can be as simple as deep sump catch basins, oil-water separators or can be innovative storm water treatment devices. The design of the treatment train and selection of pretreatment devices by the design engineer is often driven by regulatory requirements. Whether pretreatment is used or not, the Isolator Row is recommended by StormTech as an effective means to minimize maintenance requirements and maintenance costs.

*Note: See the StormTech Design Manual for detailed information on designing inlets for a StormTech system, including the Isolator Row.*



Looking down the Isolator Row from the manhole opening, woven geotextile is shown between the chamber and stone base.



StormTech Isolator Row with Overflow Spillway (not to scale)

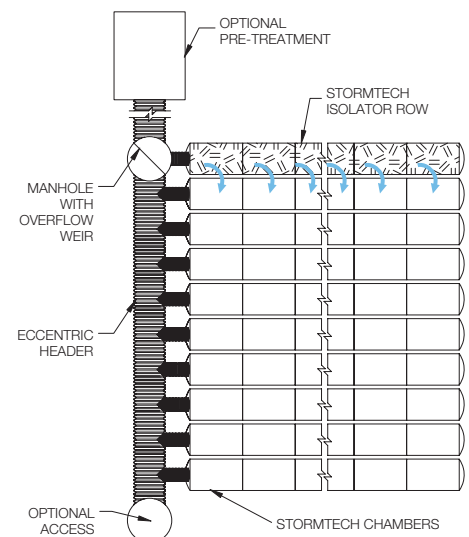



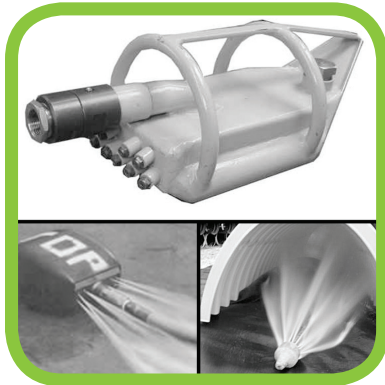

## ISOLATOR ROW INSPECTION/MAINTENANCE

### INSPECTION

The frequency of inspection and maintenance varies by location. A routine inspection schedule needs to be established for each individual location based upon site specific variables. The type of land use (i.e. industrial, commercial, residential), anticipated pollutant load, percent imperviousness, climate, etc. all play a critical role in determining the actual frequency of inspection and maintenance practices.

At a minimum, StormTech recommends annual inspections. Initially, the Isolator Row should be inspected every 6 months for the first year of operation. For subsequent years, the inspection should be adjusted based upon previous observation of sediment deposition.

The Isolator Row incorporates a combination of standard manhole(s) and strategically located inspection ports (as needed). The inspection ports allow for easy access to the system from the surface, eliminating the need to perform a confined space entry for inspection purposes.

If upon visual inspection it is found that sediment has accumulated, a stadia rod should be inserted to determine the depth of sediment. When the average depth of sediment exceeds 3 inches throughout the length of the Isolator Row, clean-out should be performed.

### MAINTENANCE

The Isolator Row was designed to reduce the cost of periodic maintenance. By “isolating” sediments to just one row, costs are dramatically reduced by eliminating the need to clean out each row of the entire storage bed. If inspection indicates the potential need for maintenance, access is provided via a manhole(s) located on the end(s) of the row for cleanout. If entry into the manhole is required, please follow local and OSHA rules for a confined space entries.

Maintenance is accomplished with the JetVac process. The JetVac process utilizes a high pressure water nozzle to propel itself down the Isolator Row while scouring and suspending sediments. As the nozzle is retrieved, the captured pollutants are flushed back into the manhole for vacuuming. Most sewer and pipe maintenance companies have vacuum/JetVac combination vehicles. Selection of an appropriate JetVac nozzle will improve maintenance efficiency. Fixed nozzles designed for culverts or large diameter pipe cleaning are preferable. Rear facing jets with an effective spread of at least 45” are best. Most JetVac reels have 400 feet of hose allowing maintenance of an Isolator Row up to 50 chambers long. **The JetVac process shall only be performed on StormTech Isolator Rows that have AASHTO class 1 woven geotextile (as specified by StormTech) over their angular base stone.**

### StormTech Isolator Row (not to scale)

*Note: Non-woven fabric is only required over the inlet pipe connection into the end cap for SC-160LP, DC-780, MC-3500 and MC-4500 chamber models and is not required over the entire Isolator Row.*

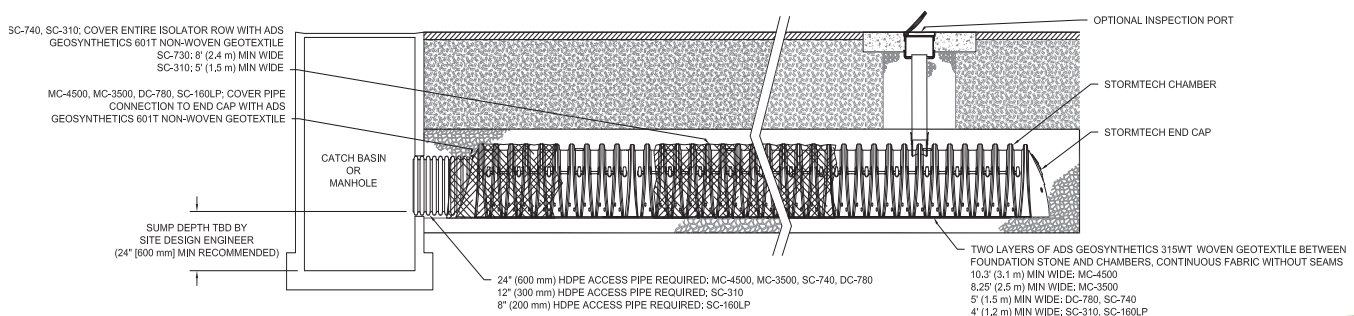

# ISOLATOR ROW STEP BY STEP MAINTENANCE PROCEDURES

## STEP 1

Inspect Isolator Row for sediment.

- A) Inspection ports (if present)
  - i. Remove lid from floor box frame
  - ii. Remove cap from inspection riser
  - iii. Using a flashlight and stadia rod, measure depth of sediment and record results on maintenance log.
  - iv. If sediment is at or above 3 inch depth, proceed to Step 2. If not, proceed to Step 3.
- B) All Isolator Rows
  - i. Remove cover from manhole at upstream end of Isolator Row
  - ii. Using a flashlight, inspect down Isolator Row through outlet pipe
    - 1. Mirrors on poles or cameras may be used to avoid a confined space entry
    - 2. Follow OSHA regulations for confined space entry if entering manhole
  - iii. If sediment is at or above the lower row of sidewall holes (approximately 3 inches), proceed to Step 2. If not, proceed to Step 3.

## STEP 2

Clean out Isolator Row using the JetVac process.

- A) A fixed floor cleaning nozzle with rear facing nozzle spread of 45 inches or more is preferable
- B) Apply multiple passes of JetVac until backflush water is clean
- C) Vacuum manhole sump as required

## STEP 3

Replace all caps, lids and covers, record observations and actions.

## STEP 4

Inspect & clean catch basins and manholes upstream of the StormTech system.

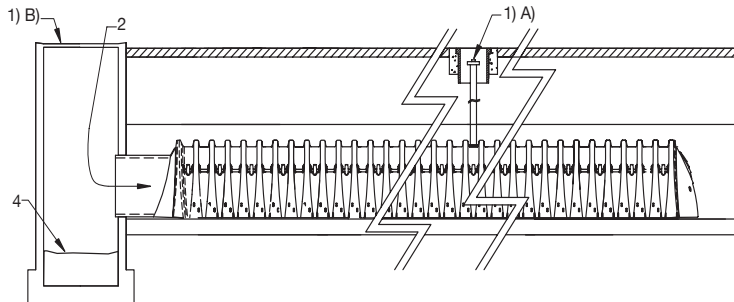

## SAMPLE MAINTENANCE LOG

Date	Stadia Rod Readings		Sediment Depth (1)-(2)	Observations/Actions	Inspector
	Fixed point to chamber bottom (1)	Fixed point to top of sediment (2)			
3/15/11	6.3 ft	none		New installation. Fixed point is CI frame at grade	DJM
9/24/11		6.2	0.1 ft	Some grit felt	SM
6/20/13		5.8	0.5 ft	Mucky feel, debris visible in manhole and in Isolator Row, maintenance due	NV
7/7/13	6.3 ft		0	System jetted and vacuumed	DJM